

# User Guide

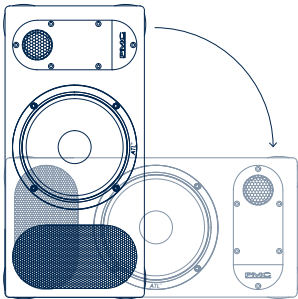

*reference monitoring all ways*

**ATL**™  
Advanced Transmission Line

Model

Serial No.

Hand built by

**PMC**®

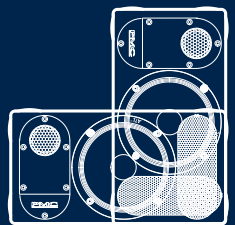

# IMPORTANT



## Warranty Certificate

Please take a few moments to complete the warranty card at the back of this booklet (or register at [www.pmc-speakers.com](http://www.pmc-speakers.com)) as this not only records the purchase of your loudspeakers, but also provides you with an opportunity to make suggestions and provide feedback directly to PMC.

## Product Support

For product support, accessories or servicing advice, please contact a PMC authorised dealer/distributor. See [www.pmc-speakers.com](http://www.pmc-speakers.com) and click on 'Where to buy'.

## Company Details

THE PROFESSIONAL MONITOR COMPANY LIMITED  
HOLME COURT, BIGGLESWADE, SG18 9ST, UK  
T +44 (0) 1767 686300

[sales@pmc-speakers.com](mailto:sales@pmc-speakers.com)    [www.pmc-speakers.com](http://www.pmc-speakers.com)

© 2019 PMC. All rights reserved.

PMC stock code: 14594 . Ref. no - 317 v6

This document should not be construed as a commitment on the part of PMC. The information it contains is subject to change without notice. PMC assumes no responsibility for any errors within this document.

CE Conformity: PMC active loudspeakers conform to EC Directive LVD2006/95/EC and EMC 2004/108/EC.

WEEE European directive: PMC is a member of a National Compliance scheme and has gained the associated certification of compliance from the Environment Agency with the registration WEEE/GJ0101WU.

### WEEE EU Directive

This symbol on the product, and in or on its packaging, indicates that this product must not be disposed of with other household waste. It is the responsibility of the owner to dispose of waste equipment via a designated collection point for the recycling of waste electrical and electronic equipment. The recycling of waste equipment is an attempt to conserve natural resources and ensures that it is recycled in a manner that protects human health and the environment. For more information about where to dispose of waste equipment for recycling, please contact your local waste/recycling authority or the dealer from whom you purchased the product.



## A message from Peter & Oliver Thomas



Our sole aim while designing loudspeakers is to recreate the true essence of an artist's intention, combining the ultimate level of sonic resolution with solid engineering principles.

We believe that the same loudspeaker can be used throughout the entire audio chain, from composer to studio or film stage, post-production or mastering and then, finally, the consumer. We also think that a well designed loudspeaker should be able to excel regardless of the audio genre, and reproduce spoken word, rock, pop, or classical music with the same precision and accuracy. Our unswerving passion for getting it right has made this goal possible.

Thank you for choosing PMC products. Please read this user guide and install your new **twotwo** series monitors bearing in mind the advice given within.

# Congratulations - You have joined the elite.

**PMC: the authority for quality sound.**

**Stevie Wonder**

Pinewood Studios

**BBC**

**Tony Bennett**

**EMI**

Warner Music

**Coldplay**

elbow

Metropolis Studios

Over more than two decades PMC has earned an unrivalled reputation for creating the world's finest professional loudspeakers. Simply put, our loudspeakers provide a reference for the very highest profile productions and events. They are found at every stage of the creative process, from conception to recording and broadcast and, of course, in the home.

Our client list reads like a who's who of the sonically aware, with Stevie Wonder, Elbow, Coldplay, Brian May, Universal, EMI, Sony, Capitol Studios, Pinewood Studios, Dreamworks, Metropolis Studios and the BBC among the makers of movies and music who use our products.

Our loudspeakers were also used in the production of Titanic, The Bourne Supremacy, Game of Thrones, Skyfall, Finding Dory, the Pirates of the Caribbean franchise, and during broadcasts of the London Olympics, 2012.

**UNIVERSAL MUSIC GROUP**

**Thomas Newman**

*Afrojack*

**Kraftwerk**

**JVC Studios**

**SONY**

**ESPN**

**Capitol Studios**

**Google**

# User guide

## Contents

- 7 General usage guidelines
- 8 Introduction
- 9 Unpacking and care
- 10 PMC's **ATL™** – How the Advanced Transmission Line works
- 11 System description
- 12 User EQ options
- 13 Connections
- 14 Running in
- 15 Applications and accessories
- 16 Positioning
- 19 Surround system set-up
- 20 Specifications
- 22 Operational controls
- 25 Notes
- 26 Service
- 27 The PMC range
- 28 The Matching active **twotwo** subs
- 29 Our meticulous care and attention
- 30 Inspection certificate
- 31 Warranty online
- 32 Warranty certificate – Part 1 – Your copy
- 33 Warranty certificate – Part 2 – PMC's copy
- 34 Your Comments – Help us improve

# Important safety instructions

- 1 Read these instructions.
- 2 Keep these instructions.
- 3 Heed all instructions.
- 4 Follow all instructions.
- 5 Do not use this apparatus near water.
- 6 Clean only with dry cloth.
- 7 Do not use solvents, abrasives, waxes or liquids as they may be detrimental to the finish.
- 8 Do not block any ventilation openings. Install in accordance with the manufacturer's instructions.
- 9 Do not install near any heat sources such as radiators, heat registers, stoves, or other apparatus (including amplifiers) that produce heat.
- 10 Do not defeat the safety purpose of the polarized or grounding-type plug. A polarized plug has two blades with one wider than the other. A grounding type plug has two blades and a third grounding prong. The wide blade or the third prong are provided for your safety. If the provided plug does not fit into your outlet, consult an electrician for replacement of the obsolete outlet.
- 11 Protect the power cord from being walked on or pinched particularly at plugs, convenience receptacles, and the point where they exit from the apparatus.
- 12 Only use attachments/ accessories specified by the manufacturer.
- 13 Use only with the cart, stand, tripod, bracket, or table specified by the manufacturer, or sold with the apparatus. When a cart is used, caution when moving the cart/apparatus combination to avoid injury from tip-over.
- 14 Unplug this apparatus during lightening storms or when unused for long periods of time.
- 15 Refer all servicing to qualified service personnel. Servicing is required when the apparatus has been damaged in any way, such as power-supply cord or plug is damaged, liquid has been spilled or objects have fallen into the apparatus, the apparatus has been exposed to rain or moisture, does not operate normally, or has been dropped.
- 16 Packaging material can pose danger to the young and vulnerable. Ensure these items are stored or disposed of safely.
- 17 The twotwo series monitor loudspeaker can produce high sound pressure levels. Exposure to high levels of sound has the potential to cause hearing damage. Use care when adjusting the system volume to ensure sound pressure levels remain within safe and comfortable limits.
- 18 Very powerful magnets are employed in the twotwo series which may have a detrimental effect on magnetically-sensitive items if placed too close, such as CRT (tube-style) televisions or monitors, and media such as cassettes and videotapes.
- 19 PMC has made efforts to provide accurate installation information and good quality fixings. However, PMC will not be held responsible or liable for injuries or property damage (direct, indirect or consequential) arising out of use or inability to use this product safely and properly.

# Introduction



Thank you for choosing PMC **twotwo** series active reference loudspeakers. This guide provides installation and operating instructions for the **twotwo.5**, **twotwo.6** and **twotwo.8** monitors, which have been specifically designed to enable use in either vertical or horizontal orientations without compromising the stereo imaging or tonal accuracy.

These monitors build upon PMC's world-class design pedigree, combining the finest drivers available with the unique **ATL™** (Advanced Transmission Line) bass loading principle, sophisticated Class-D amplification and ultra-precise DSP control.

PMC's unique **ATL™** technology uses contemporary materials to provide optimised absorption of unwanted midrange energy within the cabinet, while extending bass output significantly with negligible harmonic distortion. Please note that the **twotwo** cabinets are handed, meaning that the tweeter is offset to one side of the bass driver. In normal use the monitors should be arranged with the tweeters on the inside edge nearest the listening position.

The drivers employed in the **twotwo** monitors are bespoke PMC designs using natural materials. The newly developed 27mm precision soft-dome tweeter delivers ultra-high resolution and a neutral balance. Its perforated acoustic lens extends the response beyond 20kHz and controls dispersion to ensure perfect integration through the crossover region. The bass driver uses an ultra-light and ultra-stiff doped-paper cone to deliver unparalleled transient response and untainted mid-range.

The electronics built into each cabinet provide two channels of ultra-low distortion Class-D power amplification, with a DSP-based crossover providing perfect driver optimisation and integration. A non-aggressive protection system based on modelled excursion limiting is also implemented in the DSP, and the **twotwo** badge changes colour to red when the protection system is working. Balanced and unbalanced analogue, and AES3 digital inputs are accepted.

***'PMC's twotwo series is designed and hand-built in Britain, by nice people who care and who love audio'***

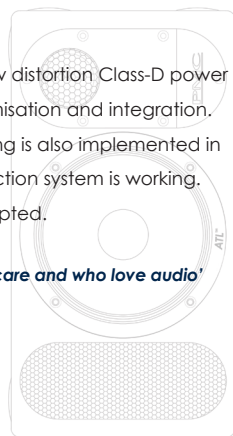
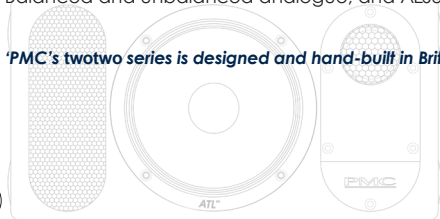



# Unpacking and care



PMC **twotwo** series active monitors are packed in heavy-duty protective cartons. Please retain these to ensure that the loudspeakers can be transported safely if the need arises in the future. If you dispose of the packaging please do so in an environmentally responsible and safe way.

## What's in the Box?

1x **twotwo.5**, **twotwo.6** or **twotwo.8** monitor  
1x AC mains power cable  
1x RJ45 control link cable  
1x User Guide



**twotwo** series monitors are heavy. Please take care when lifting them from the cartons, being particularly careful not to touch the tweeter dispersion grilles. Do not attempt to use these speakers if the packaging has been water-damaged.



**Please Note: This unit must be earthed.**

## Care and Service

In normal usage PMC speakers should provide many years of trouble-free operation, but in the unlikely event that you suspect damage or failure has occurred do not attempt to repair the unit yourself. There are no user-serviceable parts inside. Contact your dealer for advice and a service return address.

Clean the cabinets only with a dry and lint-free cloth, and avoid the use of solvents as they may damage the finish of the unit.

# Advanced Transmission Line

## How it works



PMC's unique **ATL™** (Advanced Transmission Line) enclosures have taken loudspeaker design to the highest level, using sophisticated cabinet construction, proprietary drive units, and patented absorption materials and techniques. The benefits are enormous compared to the relatively simple sealed and ported designs currently available elsewhere.

PMC's innovative approach places the bass driver near one end of a long cavity (the Advanced Transmission Line). This cavity is heavily damped with acoustic material specified carefully to absorb the upper bass and higher frequencies radiating from the rear of the bass driver. The lowest frequencies are allowed to pass down the line and emerge from the large frontal vent in the same polarity as the driver's direct radiation, the vent acting essentially as a second bass driver.

An important benefit of the **ATL™** approach is that the air pressure inside the cabinet, which loads the bass driver, remains consistent. This helps to maintain control of the driver over a wide frequency range and significantly reduces LF distortion. Consequently, the upper bass and midrange detail is not masked by harmonic distortion and the result is PMC's characteristically transparent midrange, fast, attacking bass, and outstanding clarity.

A further advantage of the ATL design approach is greater bass extension and higher SPL capability compared to typical ported or sealed designs of a similar size – even if similar drivers were used.

Moreover, the very consistent bass driver loading brings the welcome benefit that the frequency response remains consistent regardless of listening level, and analytical auditioning can be conducted without needing high replay volumes just to achieve an optimal bass response. This is a unique and very valuable characteristic of PMC's Advanced Transmission Line.

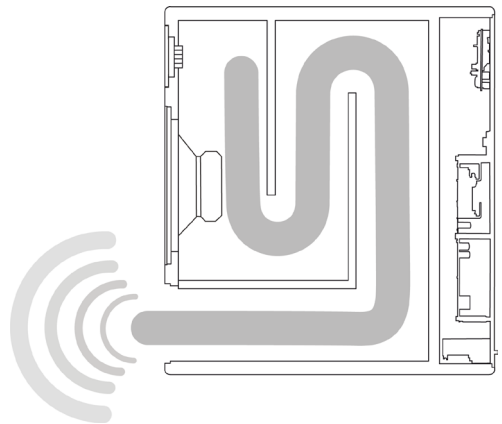

***'No other bass loading technology provides such resolution and tonal accuracy at all volume levels'***

# System description

The electronic heart of the **twotwo** series active monitor is a powerful DSP engine which operates at a fixed sample rate of 96kHz.

Balanced and unbalanced analogue inputs are conditioned by a low-noise gain stage prior to A-D conversion, to optimise the signal-noise ratio. The converter is a very high quality delta-sigma device, producing a 24-bit, 96kHz output. The AES3 digital input can accept sample rates up to 192kHz and is sample rate converted to 96kHz automatically.

The DSP engine provides the overall system volume control, 24dB/octave precision crossovers, driver optimisation, and driver

protection. This sophisticated digital signal processing ensures perfect matching between the two drivers' responses and roll-off rates, optimising the contribution of each driver, minimising distortion, and providing a flatter and more natural balance over the widest possible listening area.

The DSP system outputs are converted back to analogue to feed two separate Class-D power amplifiers and their respective drivers.

A total of 200W of high-efficiency amplification is provided, with 50W for the tweeter and 150W for the bass unit. The amplifier design ensures that driver impedance variations with frequency are fully compensated to maintain a uniform frequency response.

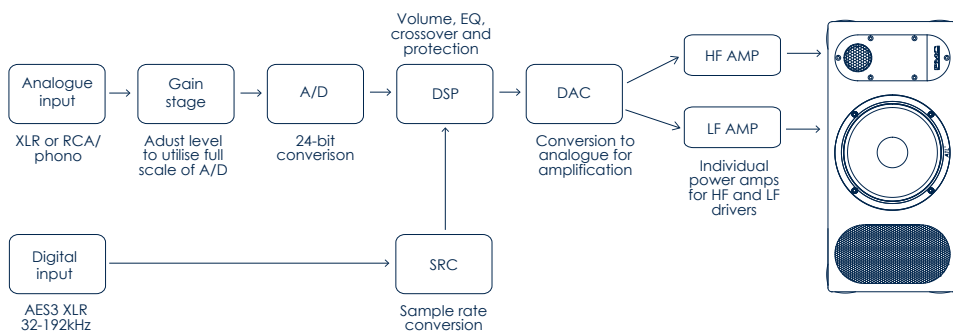

# User EQ options

PMC's **twotwo** series active monitors feature DSP-based user-equalisation options. These comprise separate low frequency (LF) and high frequency (HF) shelving responses, plus low frequency slope options. The HF and LF shelving equalisers are each adjustable over a range of  $\pm 4\text{dB}$  in increments of  $0.125\text{dB}$ . The HF shelving frequency is  $1\text{kHz}$  for both the **twotwo.5**, **twotwo.6** and **twotwo.8** models, and adjustment of the HF level can be useful in counteracting the effects of the room's acoustics and local reflections.

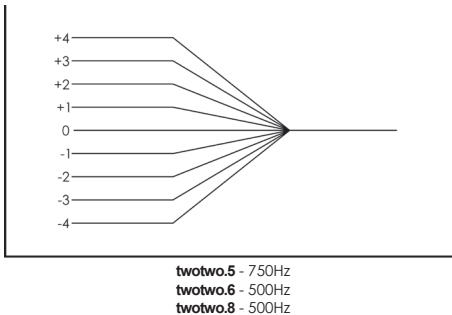
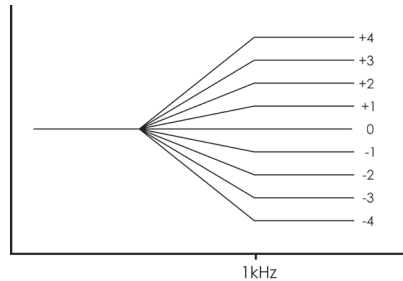

The LF shelving is different for each model because of their differently sized cabinets. For the **twotwo.5** model the bass shelving frequency is  $750\text{Hz}$ , while it is  $500\text{Hz}$  for the larger **twotwo.6** and **twotwo.8** models.

The ability to adjust the low frequency level and roll off enables compensation for the effects of room boundaries, since if a monitor is placed close to a wall or corner the perceived quantity of low frequency energy will increase, often quite dramatically and with a detrimental effect on the overall accuracy of audio reproduction.

The LF slope adjustment provides a  $6\text{dB/octave}$  high-pass filter to further assist in compensating for placement close to room boundaries.

Please see page 16 for further information on optimising the positioning of **twotwo** series monitors.

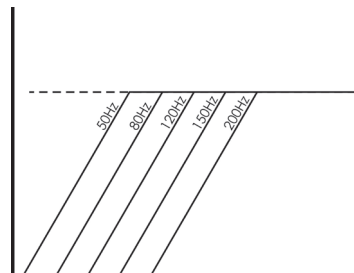

# Connections



## Caution

To avoid potential damage, please ensure that the signal source is turned off before connecting or disconnecting your active **twotwo** series loudspeakers.

## Connections

The rear panel of the **twotwo** series monitor loudspeaker carries various connectors for audio, control and mains power.

### Audio

The electronically-balanced analogue input and the AES3 digital input accept 3-pin male XLR connectors, wired with **Pin-1** screen (ground), **Pin-2** signal positive (hot), and **Pin-3** signal negative (cold). An RCA-phono socket is provided to accept unbalanced analogue signal source. The appropriate input is selected via the rear panel menu system.

### Power

The IEC (C14) mains socket is provided with adjacent power switch. There is no AC voltage selector; the **twotwo** series monitor can accept any AC mains voltage between 90-132 and 180-264V.

**THIS UNIT MUST BE EARTHED**



### In – Thru Connections

The 'IN' RJ45 socket accepts volume data and digital audio from the previous **twotwo** speaker in the chain (the first in the chain acts as the Master Volume controller). An optional Remote Control unit can also be connected to the IN socket.

The 'THRU' socket sends the control signal to the next speaker, and also passes the digital audio signal if the first speaker has a valid digital input from either its AES3 or RJ45 'IN' connectors. Note: if the AES3 XLR and RJ45 'IN' are both receiving valid digital audio, the XLR input automatically takes priority.

The **twotwo** badge on the front panel changes colour from white to red if the excursion limiting protection system is activated. If this happens reduce the input level.

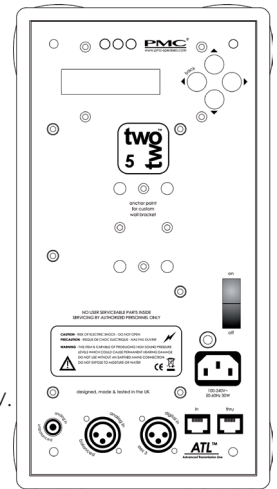

## Running-in



When brand new, PMC loudspeakers will take a short period of use before they reach their full potential.

This is because the mechanical and acoustical characteristics of the bass driver and tweeter alter slightly after manufacture as the flexible elements in their construction relax and reach their optimum compliancy. The **ATL™** cabinet parameters are critically designed to load the bass driver accurately only when it has reached its long-term, optimal compliancy.

Consequently, during the initial running-in period of about 50 hours, the performance of the **twotwo** series active monitor will change and improve. You will notice the bass tonality becoming fuller, more accurate and neutral, and the bass extension will increase significantly. As the tweeter relaxes the treble tonality also sweetens and integrates perfectly with the bass unit, and the sound staging improves.

# 50+ hours to run-in

# Applications and accessories

## Applications

The ultra-high resolution response of **twotwo** series makes them ideal for any critical evaluation of audio. Typically, **twotwo** series monitors are used for near-field monitoring of music, speech recording and mixing, in OB vehicles, radio on-air studios and TV sound control galleries, home theatre, high-end hi-fi, project studios, post-production, editing suites, music mastering, and for A&R evaluations.



## Accessories

It is ideal if monitors are positioned with the tweeter close to ear height, and kept stable during operation. The structure and materials used to support the monitor will have a bearing on how it performs. PMC offers purpose-designed high mass 'tube104 stands', with the option of the fully adjustable **twotwo** stand top plates that allow for an ideal support for the larger **twotwo.6** and **twotwo.8** monitors in either vertically or horizontal positions. Dedicated wall brackets are also available to support the **twotwo.5** and **twotwo.6** monitors.

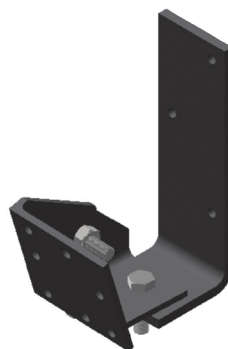

# Positioning

With their unique **ATL™** cabinet design, wide dispersion, ultra-low distortion, and smooth bass roll-off, PMC loudspeakers are more forgiving of difficult room conditions and placement constraints than conventional designs – you will be able to achieve a superb sound throughout the room with little effort. However, we encourage you to spend some time experimenting in your own room to achieve the very best results, remembering that small changes in location can often influence system performance significantly. The following guidelines are suggestions for a starting point to locate your new loudspeakers. Fine-tuning of their positioning can start from there.

## *Dispersion and Toeing-in*

Most loudspeakers have a relatively narrow dispersion and are designed to be aimed directly at the listening position, as shown in the left-hand image below. However, the excellent stereo imaging which PMC monitors are known for is due, in part, to their wide dispersion characteristic, as shown on the right-hand image. To optimise the stereo imaging, PMC monitors should be angled so that their axes cross about 0.5 metres (2ft) behind the listening position (as illustrated below). Varying the 'toe-in' angle to adjust the actual point at which the speaker axes crossover will subtly affect the vividness of the audio soundstage.

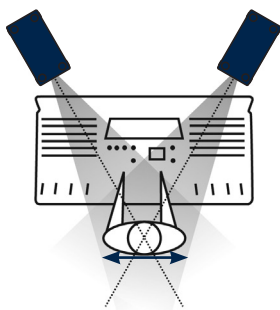

Conventional monitors have narrow dispersion which restricts the width of the accurate listening area

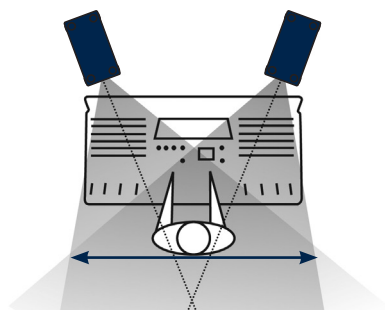

PMC Monitors have wide dispersion to provide accurate sound across the widest possible listening area



When initially positioning the loudspeakers, ideally they should be located at two of the three points of an equilateral triangle, with the listener at the third. If the monitors are spaced too far apart the stereo image will be wide but central definition will be impaired. Use a well recorded vocal track to judge the ideal placement.

Attention should be paid to the effect of reflective surfaces such as side walls and objects in close proximity to the loudspeakers, such as computer screens. Excessive nearfield reflections from these kinds of objects will blur the stereo imaging significantly, and may introduce unwelcome colouration of the sound.

**TIP** Place the speakers so that their front baffles are well forward of any objects placed between them, such as computer display screens.

With regard to optimising the speaker height, the acoustic axis of all **twotwo** cabinets is midway between the HF and LF drivers. This axis should be level with the listener's ears.

**TIP** To prevent vertical room modes from causing boominess, do not position the speaker such that the bass driver is at an even proportion of the room height, such as a half or a quarter.

### Speaker Orientation

**twotwo** series monitors are designed to be used either in upright (portrait) or horizontal (landscape) orientations without affecting the tonal or stereo imaging performance. This also allows their use as a low profile centre channel in surrounded systems. For this reason, **twotwo** series monitors are 'handed', and in normal applications the tweeters should be placed on the 'inside' of the listening triangle, as these illustrations demonstrate.

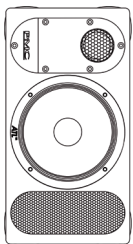

left

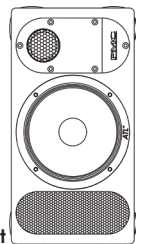

right

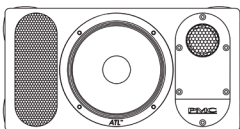

left

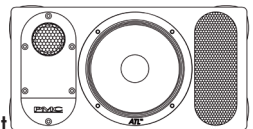

right

# Positioning (cont.)

## Bass Response

**twotwo** series active monitors can produce significant bass energy below the frequencies at which they become omnidirectional. As a consequence, it is important to consider the effect of the boundaries of the listening room when placing the monitors.

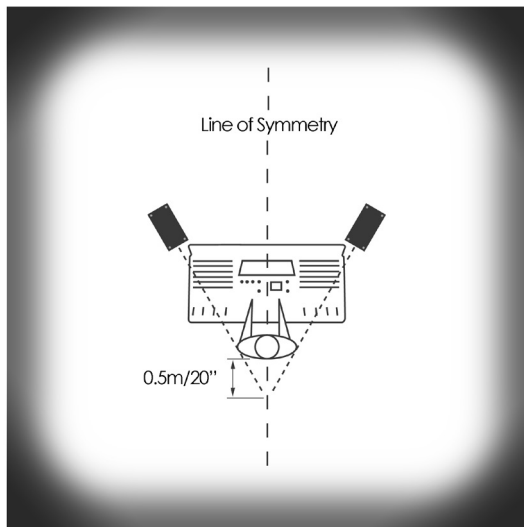

+ Bass Gain -

### TIP

Ideally, the monitors should be placed more than 0.5 metres from the side and rear walls of the room so that reinforcement and cancellation (peaks and dips) of the bass output caused by wall reflections will be moved higher in frequency and thus less influential. This reduces the incidence of 'lumpy' or 'boomy' bass. Small changes in position can have profound effects on the bass response, so experiment to find the optimal position.

# Surround sound systems

## 5.1 Systems

The **twotwo** series has been designed for perfect multi-channel music or movie playback. The following diagrams indicate the ideal speaker layouts.

**TIP** The constraints of room size and shape will often force some loudspeakers to be placed closer or further from the listening position than is ideal. In such situations the time-alignment facilities of the surround processor or monitor controller should be employed to compensate.

**TIP** When bass management is being used the subwoofer carries not only the LFE signal, but also the low bass from some, or all, of the main monitors as well. The subwoofer should be placed at the front of the room, and the optimal position provides the smoothest low bass without boomy or weak notes.

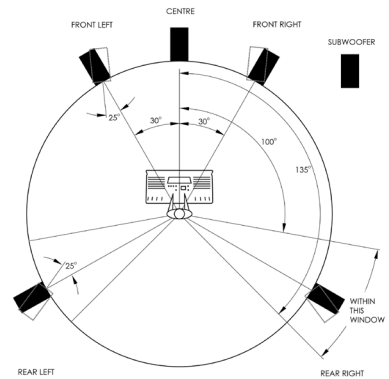

## 7.1 Systems

In a system capable of 7.1 Dolby® Digital Surround EX™, DTS® ES™ or Blu-ray™ playback there will be two sets of surround speakers. The first pair (surround or side channels) should be positioned at 100°, and the second set (rear or back channels) at 150°. (The front centre axis is 0° while directly to the rear of the room is 180°).

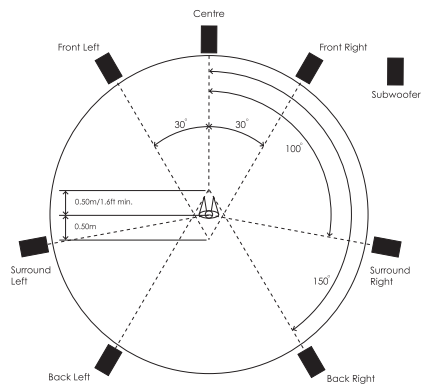

# Specifications\*



|                                  |  |  |  |
|----------------------------------|--|--|--|
| <b>Usable frequency response</b> | 50Hz - 25kHz   | 40Hz - 25kHz   | 35Hz - 25kHz   |
| <b>Maximum SPL</b>               | 111dB @1metre  | 113dB @1metre  | 115dB @1metre  |
| <b>Effective ATL length</b>      | 1.5m (4.92ft)  | 1.6m (5.25ft)  | 1.9m (6.2ft)   |
| <b>Crossover frequency</b>       | 1.8kHz   | 1.8kHz   | 1.8kHz   |
| <b>Drive units</b>               | <b>LF</b> 140mm (5.5 inch)<br><b>HF</b> 27mm Soft Dome | <b>LF</b> 170mm (6.5 inch)<br><b>HF</b> 27mm Soft Dome | <b>LF</b> 200mm (8.0 inch)<br><b>HF</b> 27mm Soft Dome |
| <b>Cabinet dimensions</b>        | <b>H</b> 296 <b>W</b> 155 <b>D</b> 295 (mm)            | <b>H</b> 406 <b>W</b> 194 <b>D</b> 364 (mm)            | <b>H</b> 500 <b>W</b> 250 <b>D</b> 415 (mm)            |
| <b>Weight</b>                    | 5.4kg  | 8.4kg  | 12.2kg   |

## Shared specifications

|                            |   |
|----------------------------|---|
| <b>Input Connectors</b>    | Balanced analogue XLR, unbalanced RCA/phono<br>AES3 digital XLR, (left/right channel selectable)<br>All XLR-3F connectors wired Pin-1 screen, Pin-2 hot, Pin-3 cold<br>Each input has independent $\pm 8$ dB trim range |
| <b>Input Sensitivity</b>   | Adjustable +4 to +15dBu   |
| <b>Digital Sample Rate</b> | 32 -192kHz, 24-bit via internal sample rate converter   |
| <b>Mains Power</b>         | IEC connector. 90-132 / 180-264V AC auto-sensing.   |
| <b>Amplifier Section</b>   | <b>LF</b> 150Wrms, <b>HF</b> 50Wrms   |
| <b>User Equalisation</b>   | <b>LF</b> Shelf $\pm 4$ dB at 750Hz ( <b>twotwo.5</b> ), 500Hz ( <b>twotwo.6</b> ) & 500Hz ( <b>twotwo.8</b> )<br><b>HF</b> Shelf $\pm 4$ dB at 1kHz<br><b>LF</b> Rolloff 6dB/octave (50, 80, 120, 150, or 200Hz)       |
| <b>Volume Range</b>        | -48.5dB to +15dB  |



left

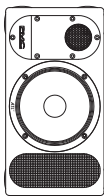

right

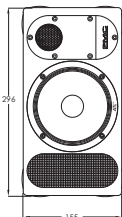

side

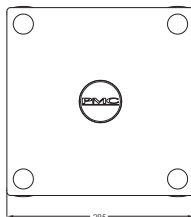

left

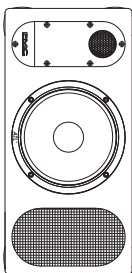

right

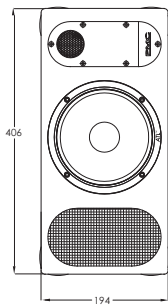

side

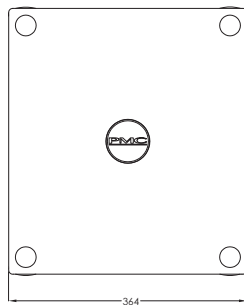

left

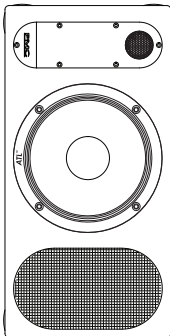

right

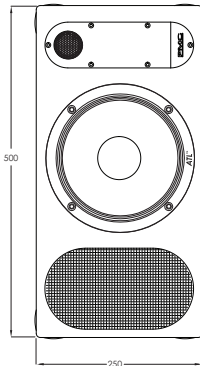

side

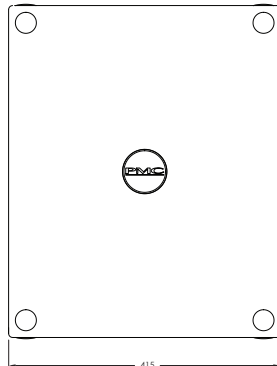

# Operational controls

The **twotwo** series monitor is configured and controlled via a simple menu system which is viewed on the rear panel display and navigated by four associated push-buttons. The first loudspeaker in the chain acts as the master volume controller.

Looking at the four cursor buttons, the left and right buttons step back (exit) and select (enter) the menu options, respectively, while the upper and lower buttons scroll through the various menu options and adjust the parameter values. The menu structure is simple, logical and intuitive, and uses clear display legends to indicate the selected function and parameter.

When the **twotwo** series monitor is connected to a mains supply it will power up in standby mode, and the display will show 'Zzz'. Pressing any of the four rear panel buttons will turn the system on.

The factory default settings will initially configure the speaker to use the analogue XLR input source, with the input sensitivity set to +12.5dB, Trim 0dB, all the equalisation set flat, backlight timeout 2 minutes, and the volume set to -20.5dB. These factory default settings can quickly be restored by pressing and holding the Up and Down buttons simultaneously for more than 2 seconds.

## Default Display

With the loudspeaker switched on, the LCD window normally indicates the current volume level and the selected input source.

The volume is indicated in decibels on the upper line of the display, within the range -48.5 to +15dB. To increase or decrease the current volume level press the up/down buttons.

The selected input source is displayed on the second line of the LCD window, with the options of: analogue XLR, analogue RCA-phonon, AES3 left or AES3 right. The graphic below illustrates the default display, in this case indicating a volume of -20.5dB and the analogue XLR input source.

|   |   |   |   |   |   |   |   |   |   |   |   |   |  |  |
|---|---|---|---|---|---|---|---|---|---|---|---|---|--|--|
| V | o | l | u | m | e | - | 2 | 0 | . | 5 | d | B |  |  |
| A | n | a | l | o | g | u | e | X | L | R |   |   |  |  |

## Power Mode

By pressing the right (enter) button, the next menu level is accessed which accesses the power standby mode. By pressing the right button again power standby is selected, and the LCD will show three Z characters to indicate the standby (Sleep) condition. The loudspeaker can be activated again by pressing any of the rear panel buttons.

|   |   |   |  |  |  |  |  |  |  |  |  |  |  |  |
|---|---|---|--|--|--|--|--|--|--|--|--|--|--|--|
| Z | z | z |  |  |  |  |  |  |  |  |  |  |  |  |
|   |   |   |  |  |  |  |  |  |  |  |  |  |  |  |

## Setup Mode

Pressing the right (enter) button twice from the default volume display accesses the Setup menu, and the up/down buttons can then be used to access the various options.

|   |   |   |   |   |  |  |  |  |  |  |  |  |  |  |  |  |  |  |  |
|---|---|---|---|---|--|--|--|--|--|--|--|--|--|--|--|--|--|--|--|
| S | e | t | u | p |  |  |  |  |  |  |  |  |  |  |  |  |  |  |  |
| T | r | i | m |   |  |  |  |  |  |  |  |  |  |  |  |  |  |  |  |

After selecting the desired option pressing the right button again displays the current parameter value, and the up/down buttons can be used to alter the value.

Pressing the left (exit) button exits the parameter level and allows other options to be selected.

|   |   |   |   |   |   |   |   |   |  |   |   |  |  |  |  |  |  |  |  |
|---|---|---|---|---|---|---|---|---|--|---|---|--|--|--|--|--|--|--|--|
| T | r | i | m |   |   |   |   |   |  |   |   |  |  |  |  |  |  |  |  |
|   |   |   | + | 0 | 0 | . | 0 | 0 |  | d | B |  |  |  |  |  |  |  |  |

### Set Up Menu Options:

|                         |   |
|-------------------------|---|
| <b>Trim</b>             | Input trim level (-8.00dB to +7.87dB)   |
| <b>Analogue In Sens</b> | Input sensitivity (+4dB to +20dB)   |
| <b>Source</b>           | Selects input source<br>(Analogue XLR, Analogue RCA, Main AES3 left, Main AES3 right)                           |
| <b>HF Shelf</b>         | Adjusts HF cut/boost level<br>Range: -4dB to +4dB in increments of 0.125dB                                      |
| <b>LF Shelf</b>         | Adjusts LF cut/boost level<br>Range: -4dB to +4dB in increments in 0.125dB                                      |
| <b>LF Rolloff</b>       | Switches the 6dB/octave bass roll-off slope On or Off.  |
| <b>LF Rolloff Freq</b>  | Selects the roll-off turnover frequency<br>Frequency options: 50, 80, 120, 150, or 200Hz                        |
| <b>BL Timeout</b>       | Sets the time after which the LCD backlight will switch off.<br>Options: 30 sec, 2 min, 5 min, off (no timeout) |

| Default Display               | Up/Down        | Press Right | Up/Down                     | Press Right | Display | Up/Down             | Press Right | Up/Down   | Default             |
|-------------------------------|----------------|-------------|-----------------------------|-------------|---------|---------------------|-------------|---|---------------------|
| Volume +xx.xdB*<br>Source: ** | -48.5 to +15dB | -           | PMC twotwo<br>Setup         | -           |         | Trim                | -           | -8.00dB to +7.87dB  | -20.5dB<br>+00.00dB |
|                               |                |             |                             |             |         | Analogue in Sens    | -           | +4dB to +20dB   | +12.50dB            |
|                               |                |             |                             |             |         | Source              | -           | Analogue XLR<br>Analogue RCA<br>Main AES3 Right<br>Main AES3 Left | Analogue XLR        |
|                               |                |             |                             |             |         |                     |             |   |                     |
|                               |                |             |                             |             |         | HF Shelf            | -           | -4.00dB to +4.00dB  | +00.00dB            |
|                               |                |             |                             |             |         | LF Shelf            | -           | -4.00dB to +4.00dB  | +00.00dB            |
|                               |                |             |                             |             |         | LF Rolloff Slope*** | -           | Off<br>On   | Off                 |
|                               |                |             |                             |             |         |                     |             |   |                     |
|                               |                |             |                             |             |         | LF Rolloff Freq     | -           | 50Hz<br>200Hz<br>150Hz<br>120Hz<br>80Hz                           | 50Hz                |
|                               |                |             |                             |             |         |                     |             |   |                     |
|                               |                |             |                             |             |         | Bl. Timeout         | -           | 2 min<br>30 sec<br>Off (no timeout)<br>5 min                      | 2 min               |
|                               |                |             |                             |             |         |                     |             |   |                     |
|                               |                |             | PMC twotwo****<br>Power Off | -           | Zzz     |                     |             |   |                     |

\* 1st amplifier in chain is master volume controller  
 \*\* 2nd line of display shows either: analogue XLR/ analogue RCA/ main AES3 left/ main AES3 right  
 \*\*\* Selection of LF rolloff is either on or off. Slope is fixed at 6dB/Oct  
 \*\*\*\* Shows **twotwo.5**, **twotwo.6** and **twotwo.8** depending on model

All menus return to default after 60 seconds of button inactivity  
 Pressing volume up and volume down together >2 sec whilst in default menu returns menus to factory defaults  
 First power-up from the mains switch boots speaker and default display





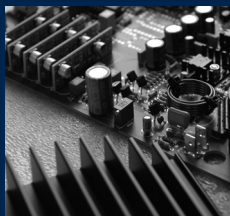

## Service

We are confident that your **twotwo** series loudspeakers will afford many years of trouble-free listening of the highest order. However, in the unlikely event of requiring repair all replacement parts will exactly match the performance of those originally installed because we record the precise value of each component along with the system response as a whole for every loudspeaker we produce.

For any issues that might arise, or for advice and service requirements, the primary point of contact should be your authorised PMC dealer/distributor.

If you do not have a local representative please see [www.pmc-speakers.com](http://www.pmc-speakers.com) and click on 'Where to buy'.

Alternatively you can view the FAQ's (Frequently Asked Questions) and servicing section on our website. (Click on the 'contacts' section and select 'FAQ').



**Important Note:** Please do not return any products to PMC directly without first contacting our service department by email at [service@pmc-speakers.com](mailto:service@pmc-speakers.com)

## The PMC range

The PMC range of professional monitors currently spans 27 different models, from the enormous QB1 XBD-A flagship system down to the diminutive **twotwo.5** active speaker. However, every monitor is designed with the same care and attention, using shared families of drive units, crossover designs and amplifiers. As a direct consequence they all enjoy the same family characteristics of wide dispersion, low distortion, consistent voicing, and an even bass response regardless of listening level. This feature allows different sizes of monitors to be used in concert to create effective multichannel systems where space is at a premium.

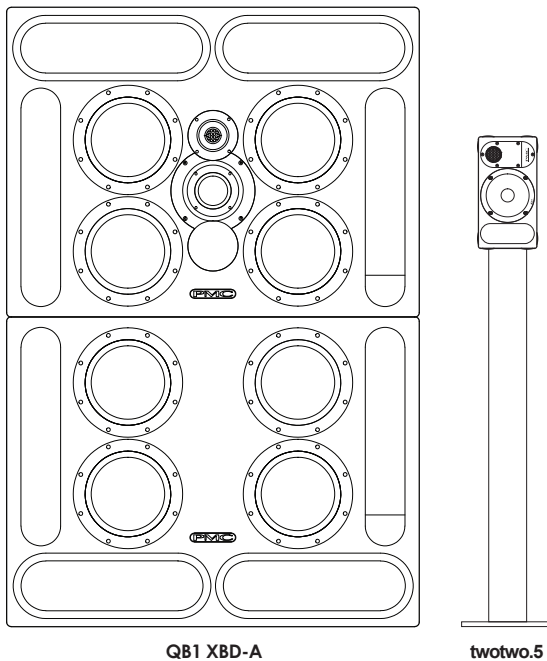

## The matching active **twotwo** subs

The **twotwo sub1** & **2** are ultra-low distortion, active subwoofers which can be used in a 2.1 configuration with twotwo series monitors to gain extra bass extension and headroom or to reproduce a low frequency effects (LFE) channel in a surround monitoring system.

Their electronics packages include 400W ultra-low distortion Class-D power amplifiers with DSP-based filtering and bass management functions. Balanced stereo analogue and AES3 digital inputs are accepted, and are combined to feed the subwoofer system, as well as being passed through to the analogue and digital outputs for connection with other devices.

For those looking for greater headroom and dynamics then the **twotwo sub2** would be the logical solution.



twotwo sub1

twotwo sub2

## Our meticulous care and attention

All PMC loudspeakers are hand-built in the U.K. using components that are individually matched to our reference model. This includes the structural integrity of every cabinet, and the testing and recording of each individual component to guarantee adherence to our strict tolerances. In this way we can ensure your purchase sounds identical to the original design.

Each completed loudspeaker then undergoes a set of objective and subjective measurements. For example, frequency response sweeps ensure that the unit meets our exacting performance criteria, and critical listening tests are conducted against the reference model using a wide variety of audio material, from a benchmark BBC speech recording to carefully selected classical music, pop and rock tracks.



# Inspection certificate

Every component employed within a PMC product is measured, tested, matched and recorded by hand. This analysis also applies to the final product to ensure you receive an identical replica of the original reference model.

- Enclosure finish
- Assembly & Wiring
- Driver installation
- Enclosure seal
- Level – Frequency
- Pair matching
- Listening test 1
- Listening test 2
- Final inspection
- Accessory pack
- User Guide

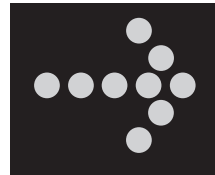

These have all been carefully checked by the builder of your **twotwo** series monitors

## Warranty online

PLEASE ACTIVATE YOUR 5-YEAR  
WARRANTY ONLINE

**GO TO [WWW.PMC-SPEAKERS.COM](http://WWW.PMC-SPEAKERS.COM) AND CLICK ON REGISTER PRODUCT**



**If you do not have access to the Internet please fill in the Warranty form on pages 33 and 34, and return to PMC.**

# WARRANTY CERTIFICATE - PART 1

Your copy  
to keep

**Please complete and retain this page for your own records**

Product

Serial No's

Date of purchase

Dealer's name

Dealer's address

Town

County

Postcode

Dealer's Telephone No.

**Servicing and warranty issues – Please read the following carefully.**

**Non-UK clients**

Contact your local dealer/distributor for the details of warranty repairs – see [www.pmc-speakers.com](http://www.pmc-speakers.com) and click on distribution for their details.

**UK clients**

In the unlikely event of a fault occurring with your PMC product please contact your dealer where the product was purchased.

Do not return a product to PMC without firstly contacting our technical department. If the product needs to be returned for service you will be issued with a Returns Authorisation number.

If a product is returned to PMC and subsequently is found to have no fault or a non-warranty fault there will be minimum charge of £50.00 plus the carriage for its return.

Proof of purchase is required for any claim covered by this warranty.

This product is warranted for a period of five years from the date of purchase or valid warranty registration which is either by receipt of the 'Our Copy' card or an on-line registration which must be made within ten days of purchase or receipt.

The warranty covers defects due to faulty materials or workmanship but does not cover defects arising from accidental damage, misuse or wear and tear. The warranty is void if any attempt has been made by persons not authorised by PMC to dismantle, repair or modify any part of the product.

Products must be returned using original packing material. This warranty does not cover damage in transit.

Note that the cost of the carriage to PMC is not covered by the warranty.

Returned products that are defective but no longer covered by warranty will be repaired or replaced at the discretion of PMC.

Please allow a minimum of 14 working days for return of warranty repairs.

This warranty does not affect your consumer rights under statutory law. This warranty certificate is only valid in the United Kingdom.

THE PROFESSIONAL MONITOR COMPANY LIMITED Holme Court Biggleswade SG18 9ST UK T+44 (0) 1767 686300



# WARRANTY CERTIFICATE - PART 2

PMC's copy

Please complete and return this section – or simply complete the on-line registration at [www.pmc-speakers.com](http://www.pmc-speakers.com) and click on 'register product.'

Help us to improve  
our products.  
See over



# Help us Improve. Your Comments?

We value all of our clients' comments. Please take a moment to help us improve:

If there is one thing we should change, what would it be?

Please tell us how your new PMC loudspeakers perform. Your comments may appear on the customer quotes section for this product on our website – but don't worry, the comments will be anonymous and your personal details will not be published.

## Which magazines do you read?

### HiFi

HiFi Choice

What HiFi

Stereophile

HiFi World

HiFi Critic

HiFi News

HiFi+

Gramophone

### Pro

Future Music

Sound On Sound

Audio Media

Pro Sound News

Resolution

Audio Fanzine

IBE

Tape Op

### Lifestyle

T3

Stuff

GQ

Mens Health

FHM

Loaded

Maxim

Esquire

### On-Line

mixonline.com

gearslutz.com

avreview.co.uk

avforums.com

HiFi WigWam.com

What HiFi.com

SoundonSound.com

SoundonSound/forum

***'We hope you enjoy your latest purchase as much as we enjoyed designing and building them – Thank you'***

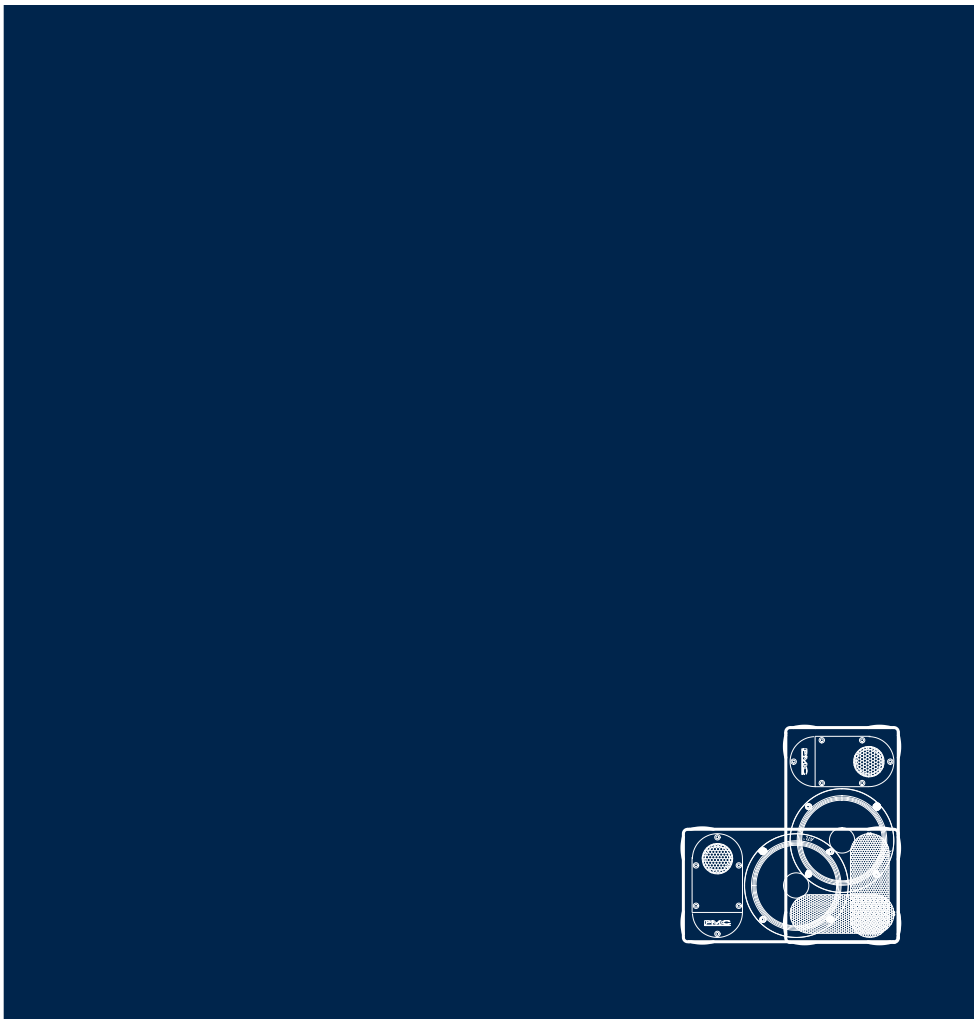

**twotwo** is a trademark of The Professional Monitor Company Limited.

This document should not be construed as a commitment on the part of The Professional Monitor Company Limited.

The Professional Monitor Company Limited will not assume responsibility for errors that may appear in this document.

Information may be subject to change.



**PMC**<sup>®</sup>

T + 44 (0) 1767 686300  
sales@pmc-speakers.com  
www.pmc-speakers.com

PMC stock code: 14594  
Ref No. 317v6-May19