



PMC[®]

PMC6

PMC6-2

PMC8-2

PMC8 SUB

PMC8-2 SUB

PM

THE BAR HAS BEEN RAISED



TRUE

Discerning music makers regard our monitors as the absolute reference; they are found throughout the audio chain, from composer to recording or mixing, through post-production, mastering and broadcast. They deliver a forensic level of detail that allows you to work faster without fatigue with complete confidence, knowing that your finished mix will translate technically and emotionally anywhere. Our signature sound — ultra-low distortion, effortlessly extended bass, and smooth, super-wide dispersion — is a feature of every monitor, from compact nearfield to our large main monitors.

This renowned flexibility and dependability are the result of our holistic design process in which the impact on overall performance of every part of our speakers is carefully considered, down to component level. We take this approach with every design we manufacture, including our latest generation of active reference near and midfields, the PMC6, PMC6-2, and PMC8-2, and their associated subwoofers the PMC8 SUB and PMC8-2 SUB.

Designed from the ground up with more than five years R&D combined with invaluable input from the PMC community, these British-made monitors are aimed at audio recording, mixing, mastering, and broadcast professionals working in any format from stereo to immersive sound. The range is packed with innovations including all-new drive units, cutting-edge Class-D amplification, DSP-controlled crossovers, and the latest generation of our proprietary ATL™ bass-loading and Laminair™ air flow technologies. With digital connectivity and configurable via the class leading SoundAlign interface (PC or Mac), these scalable systems give users the option of adding active subs either standalone for multichannel and immersive systems, or to create PMC's unique XBD configuration for extended bass response and headroom.

Whether you're composing, recording, mixing, or mastering in stereo or the latest immersive formats, you can guarantee the best possible results in the shortest possible time.

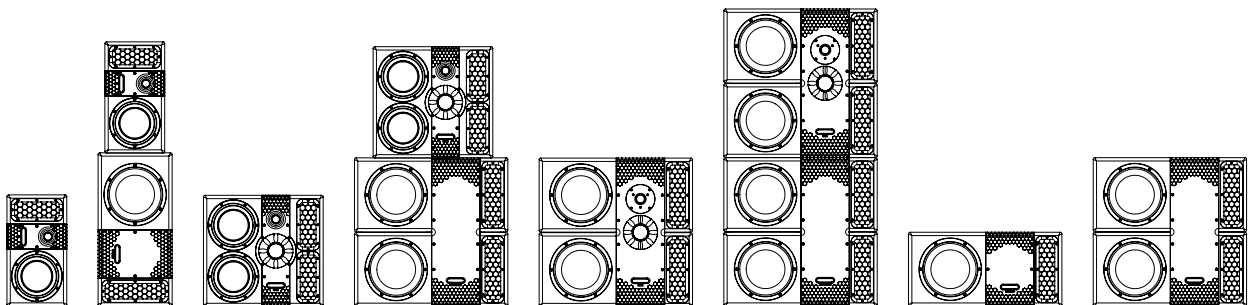

“Work faster without fatigue and with complete confidence.”



PMC6

If you are a professional who needs the last word in reliable reference monitoring in a compact form, then the PMC6 active two-way is the answer. Packed with innovation and providing the same sonic signature as our renowned larger monitors, it's ideal for smaller control rooms or for use in larger immersive systems, where its astounding resolution allows critical mix decisions to be made with absolute confidence.

With 20mm of excursion, the bespoke 6-inch bass driver is designed specifically to integrate with our latest ATL™ bass-loading and Laminair™ airflow technologies. The combination outperforms most 8-inch monitors, offering unparalleled bass extension, headroom, dynamics, and low distortion at all levels. The high end is courtesy of a one-inch precision-built fabric soft-dome tweeter, with a shallow waveguide that creates wide, tonally consistent dispersion and rock-solid imaging. Both the bass and treble drivers are precisely and individually controlled by a pair of 200W ultra-low-distortion, high-damping-factor Class-D amplifiers.

Whether in portrait or landscape placement, the PMC6's sophisticated DSP engine automatically adjusts the crossover, ensuring optimum tonal accuracy, phase and imaging.

The monitor can be calibrated using the rear-panel controls or with PMC's intuitive browser-accessible SoundAlign software.

The PMC6 can be upgraded by adding a PMC8 SUB to create a full-range, free-standing PMC6 XBD system. Activating the 'XBD' DSP mode ensures the perfect marriage of the two units, creating a clean LF extension down to 25Hz.

- Active 2-way nearfield reference monitor with ATL™ bass loading
- Frequency response: 39Hz - 25kHz (-3dB @1m full space, on-axis)
- Max. cont. SPL: 106dB @1m (Half space value calculated as +3dB from full space measurement. Unweighted input, 20-20kHz Pink Noise (IEC) with 12dB CF for 2 hours AES2-1984 duration)
- State-of-the-art Class-D amplifiers: HF 200W, LF 200W
- Analogue/AES3 digital input (16/24-bit, 18 -192kHz sample rate)
- Digital 'through' output (AES3 24-bit 96kHz)
- SoundAlign network control interface for single or group EQ & settings
- Sophisticated DSP crossover, driver protection, EQ, and delay/polarity options
- Automatic portrait/landscape placement DSP correction
- PMC6 + PMC8 SUB creates PMC6 XBD, with LF extension down to 25Hz
- Ceiling-mount yoke allows suspension in multi-channel or immersive systems

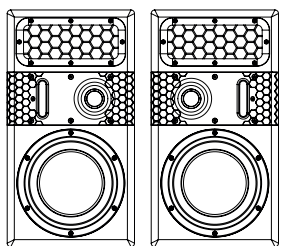

PMC6
(left vertical) **PMC6**
(right vertical)

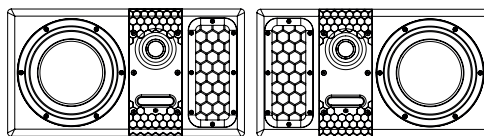

PMC6
(left horizontal) **PMC6**
(right horizontal)

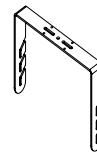

YOKE 18
(ceiling mount)



A serious near/midfield monitoring tool that fits easily within any control room or immersive system, the PMC6-2 is unmatched in its outstanding clarity, forensic resolution, and sheer impact. It provides main-monitor scale, depth, and dynamics, and allows mix decisions to be made quickly, with absolute certainty and without fatigue.

This 3-way active monitor speaker combines two custom 6-inch ultra-long-throw bass-drivers with our radically engineered PMC55 2-inch soft-dome mid-range unit and a precision-built one-inch soft-dome tweeter. The PMC55's distinctive 'N-compass' waveguide enhances the wide dispersion and remarkable mid-range projection of the driver; in combination with the high performance of the tweeter, the result is an ultra-wide and stable image, with a smooth and natural in-room response. Each bass driver is individually powered by a cutting-edge 400W Class-D amplifier, and seamlessly integrated by our sophisticated, highly accurate DSP-based crossovers. As with the PMC6, the monitor is configured using rear-panel controls or the browser-based SoundAlign software, with comprehensive boundary and EQ options.

The PMC6-2 offers astonishing size-to-performance ratio thanks to its ATL™ bass-loading technology, which results in exceptional LF extension and consistent tonal balance at all listening levels. Our Laminair™ airflow technology, visible in the monitor's hexagonal vent ducts, further reduces colouration and enhances dynamics and efficiency.

A simple upgrade path converts the PMC6-2 to a full-range XBD system; just add a PMC8.2 SUB and select XBD mode to perfectly dovetail the two units, extending the response down to 25Hz with additional headroom.

- Active 3-way nearfield reference monitor with ATL™ bass loading
- Frequency response: 33Hz - 25kHz (-3dB @1m full space, on-axis)
- Max. cont. SPL: 109dB @1m (Half space value calculated as +3dB from full space measurement. Unweighted input, 20-20kHz Pink Noise (IEC) with 12dB CF for 2 hours AES2-1984 duration)
- State-of-the-art Class-D amplifiers: HF 400W, MF 400W, LF 2x 400W
- Analogue / AES3 digital input (16/24-bit, 18 -192kHz sample rate)
- Digital 'through' output (AES3 24-bit 96kHz)
- SoundAlign network control interface for single or group EQ & settings
- Sophisticated DSP crossover, driver protection, EQ, and delay/polarity options
- PMC6-2 + PMC8.2 SUB = PMC6-2 XBD, with LF down to 25Hz & increased headroom
- Ceiling-mount yoke allows suspension in multi-channel or immersive systems

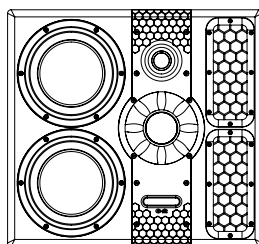

PMC6-2
(left)

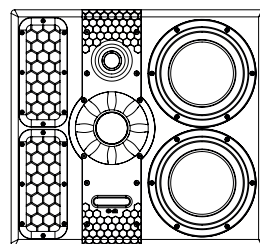

PMC6-2
(right)

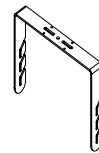

YOKE 18
(ceiling mount)



With its larger cabinet, pair of powerful 8-inch long-throw bass drivers and huge dynamic range, this three-way active studio monitor is designed to provide critical reference monitoring in the most demanding environments, including for large-scale scoring sessions and in post-production and mastering suites. As with any PMC loudspeaker, thanks to its super-consistent dispersion and tonal balance, the PMC8-2 may be simply and seamlessly combined with smaller PMC speakers to create larger multi-channel or immersive systems.

The twin bass drivers are partnered with the same PMC55 mid-range tweeter, DSP system and four channels of 400W Class-D amplification used in the PMC6-2. Again, the speaker is configurable directly via the rear panel or using the browser-based SoundAlign software from a computer or tablet.

Together with the precisely tuned ATL™ cabinet and hexagonal Laminair™ vents, the PMC8-2 delivers phenomenal performance that approaches that of our Main reference monitors, with smooth and consistent bass response down to 25Hz, a revealing mid-range and wide, stable sound-staging. As with the rest of the range, the PMC8-2's superb definition, fidelity, dynamics and bass accuracy allow mix decisions to be made quickly with complete confidence, and with no listening fatigue even after long sessions.

PMC8-2s can be upgraded through the addition of a PMC8-2 SUB to create an XBD system, enhancing the system's bass headroom by 6dB. Dedicated short and taller floor-stands are available for the PMC8-2 and PMC8-2 XBD systems which position them on the ideal listening axis.

- Active 3-way nearfield reference monitor with ATL™ bass loading
- Frequency response: 25Hz - 25kHz (-3dB @1m full space, on-axis)
- Max. cont. SPL: 113dB @1m (Half space value calculated as +3dB from full space measurement. Unweighted input, 20-20kHz Pink Noise (IEC) with 12dB CF for 2 hours AES2-1984 duration)
- State-of-the-art Class-D amplifiers: HF 400W, MF 400W, LF 2x 400W
- Analogue / AES3 digital input (16/24-bit, 18 -192kHz sample rate)
- Digital 'through' output (AES3 24-bit 96kHz)
- SoundAlign network control interface for single or group EQ & settings
- Sophisticated DSP crossover, driver protection, EQ, and delay/polarity options
- PMC8-2 + PMC8-2 SUB creates PMC8-2 XBD, with up to 6dB of additional headroom
- Optional dedicated floor stands for PMC8-2 (40") and PMC8-2 XBD (19")

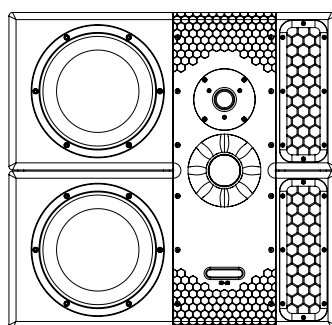

PMC8-2
(left)

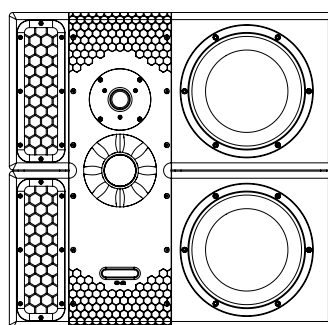

PMC8-2
(right)

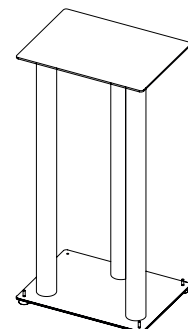

STAND
(40" stand for **PMC8-2**)



The PMC8 SUB is a true low-frequency reference monitor which extends the bass response of your speaker system, imparting more of our signature ultra-clean, ultra-fast low end to any setup. It can be used as a compact stand-alone subwoofer within conventional multichannel systems, or as an XBD cabinet (and stand), creating a full-range PMC6 XBD midfield monitor. When used in this way, the dedicated 'XBD' DSP mode marries the speakers and sub unit together, creating a coherent full-range system. Our sub units are also perfectly suited to use in multi-channel and immersive systems, as our ATL™ bass-loading technology provides a gentler low-order LF roll-off than conventional ported cabinets, allowing a smoother, seamless integration between the height and surround channels and the sub.

Featuring one custom eight-inch long-throw bass-driver, the PMC8 SUB is powered by a single 300W Class-D amplifier and controlled by the same powerful DSP engine as our other active models. DSP facilities include sophisticated room boundary equalisation options, parametric EQ, time delay, phase inversion, and the unique XBD mode, all configured via the loudspeaker's rear panel or the browser-based SoundAlign software.

- Active subwoofer with an 8-inch bass driver and ATL™ bass loading
- Frequency response: 25Hz - 500Hz (-3dB) (@1m full space, on-axis)
- Max. cont. SPL: 109dB @1m (Quarter space value calculated as +3dB from half space measurement. Unweighted input, 20-20kHz Pink Noise (IEC) with 12dB CF for 2 hours AES2-1984 duration)
- State-of-the-art Class-D amplifier: LF 1 x 300W
- Analogue/AES3 digital input (16/24-bit, 18 -192kHz sample rate)
- Digital 'through' output (AES3 24-bit 96kHz)
- SoundAlign network control interface for single or group EQ & settings
- Sophisticated DSP driver protection, EQ, and delay/phase options
- Dedicated XBD configuration mode

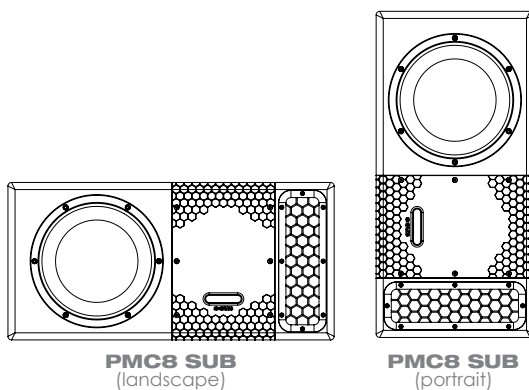



PMC8-2 SUB

The PMC8-2 SUB is a larger subwoofer for full-bandwidth, high-resolution reference monitoring in the most demanding professional environments. A true low-frequency monitor like the PMC8 SUB, and offering the same DSP engine and seamless integration with surround and immersive systems, the PMC8-2 SUB betters the spec of its smaller sibling, offering higher maximum SPL output all the way down to 25Hz.

With the same dimensions as the PMC8-2 midfield monitor, the PMC8-2 SUB's twin eight-inch bass drivers are powered by independent 400W Class-D amplifiers. The same configuration options are available as on the PMC8 SUB, accessible on the speaker's rear panel or by using the browser-based SoundAlign software via a LAN-connected tablet, smartphone or computer.

The PMC8-2 SUB can be used as a standalone subwoofer for multichannel and immersive sound systems, or as an XBD cabinet with either PMC6-2 or PMC8-2 monitors, creating a system of awesome power and dynamic range. The sub is available in either left- or right-handed cabinet versions (PMC8-2 SUB-L or PMC8-2 SUB-R), to allow placement of the bass drivers on the outside edges of a stereo array, matching the arrangement of the main monitors.

- Active subwoofer with twin 8-inch bass drivers and ATL™ bass loading
- Frequency response: 25Hz - 500Hz (-3dB) (@1m full space, on-axis)
- Max. cont. SPL: 115dB @1m (Quarter space value calculated as +3dB from half space measurement. Unweighted input, 20-20kHz Pink Noise (IEC) with 12dB CF for 2 hours AES2-1984 duration)
- State-of-the-art Class-D amplifier: LF 2 x 400W
- Analogue/AES3 digital input (16/24-bit, 18 - 192kHz sample rate)
- Digital 'through' output (AES3 24-bit, 96kHz)
- SoundAlign network control interface for single or group EQ & settings
- Sophisticated DSP driver protection, EQ, and delay/phase options
- Dedicated XBD configuration mode

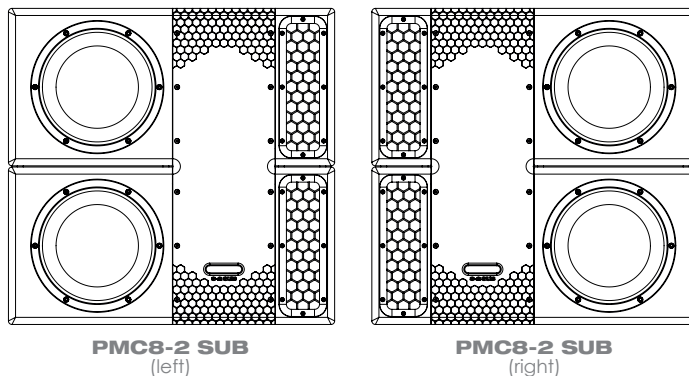



PMC6 XBD

PMC6-2 XBD

PMC8-2 XBD



PMC6 XBD
(right)



PMC6-2 XBD
(left, on bespoke 19" stand)



PMC8-2 XBD
(right, on bespoke 19" stand)

CREATING AN XBD SYSTEM

With the addition of a PMC sub unit, the PMC6, 6-2, and 8-2 can be easily reconfigured as twin-cabinet XBD monitor systems. This popular and flexible format combines a full-range speaker and subwoofer to form a perfectly integrated system with huge benefits. In the case of the PMC6, the bass response of the resulting XBD monitor is extended down to 25Hz — giving genuine midfield monitor performance in a compact installation — and the speaker becomes a three-way design. Because the mid-bass driver no longer handles the lowest bass frequencies, distortion is reduced, and the mid-range frequencies gain extra clarity, lending vocals still greater realism and depth. Configuring a PMC6-2 or 8-2 as an XBD system reinforces the bass output of the main speaker's LF drivers, greatly increasing headroom all the way down to 25Hz, creating a system with a sense of effortless capability.

It's simple to configure an XBD system; you connect the input directly to the main monitor, and add an AES3 digital cable to carry the main monitor output down to the subwoofer. When you select the dedicated 'XBD' mode, the DSP seamlessly combines both units into a single, larger-scale monitor. Further detailed configuration can be carried out from the rear-panel controls or using the intuitive SoundAlign browser-based software via the LAN connection, where both speakers appear as a single XBD unit.

“Precision tools, designed by engineers for engineers.”

Dolby Atmos





We provide ultimate monitoring solutions and support so you can truly push the boundaries of the Dolby Atmos Music format. Our professional active monitor speakers exceed Dolby's specification requirements, and our experience is unparalleled.

We are the world leader with a vast range of the highest resolution monitors available in numerous sizes and formats. All our professional active monitors can be mixed and matched completely seamlessly as their tonal characteristics and dispersion are identical – the only difference between them is their cabinet size and corresponding bass extension. Our monitors are designed to provide ultra-wide directivity to create a unified sound field, allowing individual sounds to be placed and adjusted within the soundstage with complete precision.

Most immersive sound systems employ bass-management for the surround and height channels, crossing over the lower frequencies to one or more subwoofers. In this context PMC monitors have a distinct advantage over other designs in that our unique ATL™ bass-loading technology provides a gentler low-order LF roll-off than conventional ported cabinets. This allows a smoother, seamless integration between the height and surround channels and the subwoofers.

These are just two of the reasons why you should choose PMC for your Dolby Atmos Music system, but there are many more. Our demo facilities located around the world allow you to experience all that Dolby Atmos offers and we are happy to guide you to the best and most effective solution for your studio.

SOUNDALIGN

The SoundAlign web interface is a highly intuitive and responsive means of controlling and configuring our nearfield and mid-field active DSP monitors (and the two associated subwoofers). Each monitor speaker incorporates an internal web-server accessible over a standard wired Ethernet connection using any typical web-browser on any smart-phone, tablet, PC, or Mac computer.

Loudspeakers can be controlled individually or in defined groups of multiple speakers (up to 16), and every DSP menu function and parameter can be viewed and adjusted, with configuration settings stored and recalled instantly as presets or copied between speakers. Facilities are provided to configure the input format and level, boundary mode correction, delay, and polarity options, as well as an EQ section with interactive graphical display offering five parametric bands plus high and low shelf sections.

The SoundAlign interface also makes it very simple to upload new firmware to all selected speakers, when necessary, and a group filter mode allows defined subsets of speakers to be displayed and controlled entirely separately from other groups – a brilliant asset in complex multi-room installations or with multichannel speaker arrays.

A dedicated network is not necessary – the loudspeakers can be connected to any standard LAN as the SoundAlign data happily co-exists with other network traffic (Internet access is not required, either). Alternatively, individual speakers can be configured by connecting a standard Ethernet cable directly back to the Ethernet port on a PC or Mac, or by using the controls on the rear panel.





PMC SOUNDALIGN

SUPPORT

GROUP FILTER ALL

| SELECT | GROUP | CHANNEL | MODEL | INPUT SOURCE | LEVEL TRIM | ANALOGUE IN MAX |
|----------------------------------|-------|------------|-------|--------------|------------|-----------------|
| <input type="radio"/> | A | LEFT | 6 | ANALOGUE | 0.0 dB | +20dBu |
| <input type="radio"/> | A | CENTRE | 6 | ANALOGUE | 0.0 dB | +20dBu |
| <input checked="" type="radio"/> | A | RIGHT | 6 | ANALOGUE | 0.0 dB | +20dBu |
| <input type="radio"/> | A | SURROUND L | 6 | ANALOGUE | 0.0 dB | +20dBu |
| <input type="radio"/> | B | SURROUND R | 6 | ANALOGUE | 0.0 dB | +20dBu |

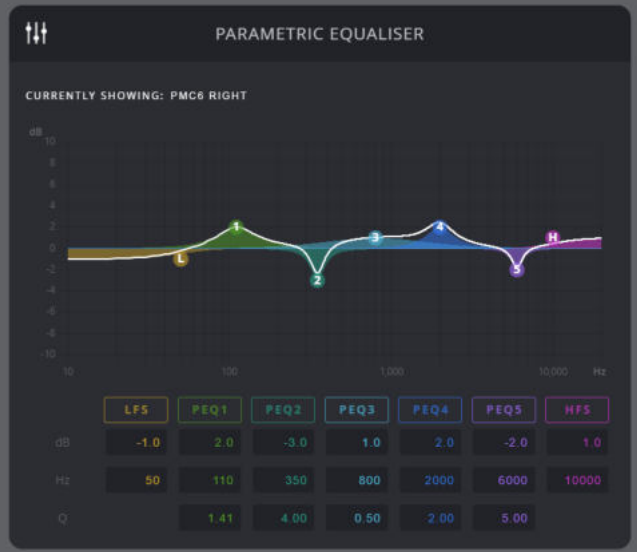

ATL™

Advanced Transmission Line

TECHNICALLY & SONICALLY SUPERIOR BASS

ATL™ bass-loading technology offers the following advantages over ported and sealed monitors:

- Exceptional LF extension with no colouration
- Identical tonal balance at all levels
- Higher SPLs without compression or listener fatigue
- More efficient
- A truly accurate response that translates



PMC's unique ATL™ (Advanced Transmission Line) enclosures have taken loudspeaker design to the highest level, using sophisticated cabinet construction, proprietary drive units, and patented absorption materials and techniques. The benefits are enormous compared to the relatively simple sealed and ported designs currently available elsewhere.

PMC's innovative approach places the bass driver near one end of a long cavity ATL™ (the Advanced Transmission Line). This cavity is heavily damped with acoustic material specified carefully to absorb the upper bass and higher frequencies radiating from the rear of the bass driver. The lowest frequencies are allowed to pass down the line and emerge from the large frontal vent in the same polarity as the driver's direct radiation, the vent acting essentially as a second bass driver.

An important benefit of the approach is that the air pressure inside the cabinet, which loads the bass driver,

remains consistent. This helps to maintain control of the driver over a wide frequency range and significantly reduces LF distortion. Consequently, the upper bass and mid-range detail is not masked by harmonic distortion and the result is PMC's characteristically transparent mid-range, fast, dynamic bass, and outstanding clarity.

A further advantage of the ATL™ design approach is greater bass extension and higher SPL capability compared to typical ported or sealed designs of a similar size and driver specification.

Moreover, the very consistent bass driver loading brings the welcome benefit that the frequency response remains consistent regardless of listening level, and analytical auditioning can be conducted without the need for high replay volumes to achieve an optimal bass response. This tonal consistency at all output levels is a unique and very valuable characteristic of PMC's Advanced Transmission Line.

ENGINEERING THE AIR ITSELF

Our holistic design process has led us to study the physics of every part of our monitors thoroughly, including air flow. Our powerful Studio drivers produce high-velocity air movements at the exit vents from our transmission lines, and careful analysis shows that the flow can become resistive and turbulent if uncontrolled. This wastes energy and leads to colouration, audible in our otherwise ultra-low-noise designs.

To address this, our Laminair™ technology, visible on the PMC6, 6-2 and 8-2 in the form of the distinctive hexagonal profiling at the vents, produces a controlled, laminar air flow. The result is faster, higher-definition bass with accurate timing, and the widest possible dynamic range.

*Streamlined, efficient
airflow with **Laminair™***

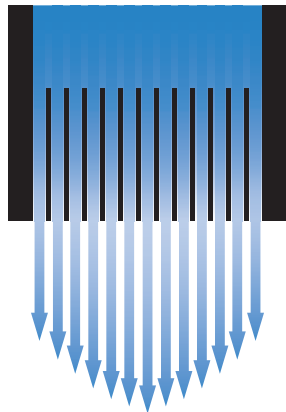

*Turbulent airflow at the
ATL™ vent without **Laminair™***

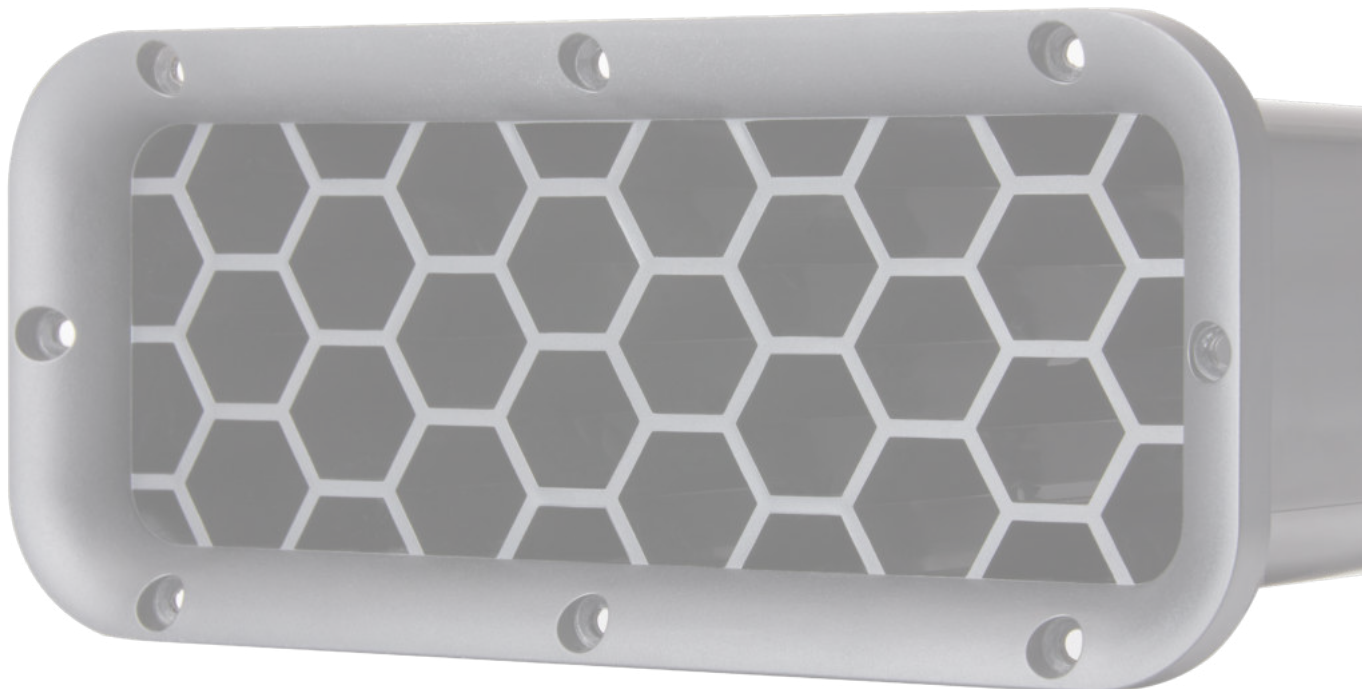
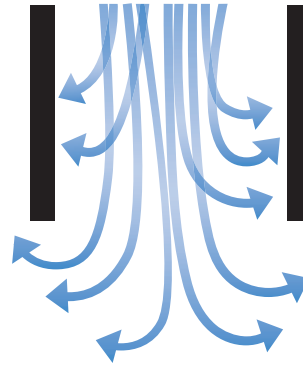





PMIC

PMIC

2214C300P16-201224



SUPREME HIGHS & MIDS

PMC's legendary reputation for its world-leading soft-dome mid-range drive units has been extended through the introduction of the PMC55 2-inch driver employed in the three-way PMC6-2 and PMC8-2 mid-field monitors. This innovative unit is a development of our renowned 3-inch PMC75 mid-range driver used in our professional Main Monitors (IB2, MB3, BB6, QB1), and is optimised for the more compact active nearfield and midfield speakers.

The front of the PMC55 unit features a uniquely-engineered dual-profile waveguide in which the exponential base profile enhances the low frequency extension, while the distinctive hyperbolic 'inclusions' ensure a smooth and wide dispersion. Working together, these twin profiles deliver perfectly matched dispersion angles throughout both crossover regions with a smooth and consistent frequency response, both on- and off-axis, guaranteeing a huge listening sweet-spot and a stable 3D sound stage.

The rear of the midrange dome is vented into a damped acoustic chamber which minimises back-pressure on the diaphragm and reduces internal reflections. The benefits are extended low-frequency bandwidth and an excellent transient response. Together these attributes deliver seamless integration with the woofer, and precise clarity, depth, and micro-dynamics in a staggeringly vivid mid-range.

All our active monitors employ one-inch silk dome tweeters, sharing the same design philosophy and sonic signature to deliver transparent, low-distortion sound even at the highest SPLs. The PMC8-2's tweeter has a larger motor assembly for higher thermal power handling and a 5dB greater SPL capability. The tweeters are mounted in shallow precision-engineered waveguides which maximise their dispersion to dovetail perfectly with the PMC55 mid-range unit or Studio6 bass unit.

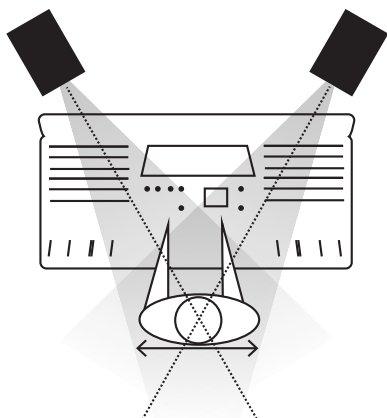

Conventional monitors have narrow dispersion which restricts the width of the accurate listening area

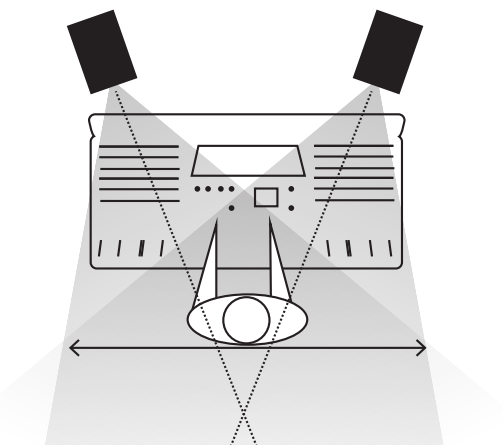

PMC Monitors have wide dispersion to provide accurate sound across the widest possible listening area



LOW DOWN & CLEAN

Every element of our active nearfield and midfield monitors has been newly engineered specifically for this application, and one very important facet in the stunning performance-to-size ratio of our active near and midfield reference monitors is our custom-designed bass drivers.

The Studio6 and Studio8 woofers have been developed hand-in-hand with the latest evolution of our unique ATL™ cabinet design with Laminair™ vents – these technologies interact with each other in such complex ways that they must be created as a single cohesive entity. The results set new standards of performance, depth, dynamics, and detail with extraordinarily compact cabinets.

Fundamental to the design of these innovative drive units is a massive, vented motor assembly comprising double-stacked magnets with an unusually long voice-coil and a very robust double-spider suspension. Together, these components maintain a consistently linear motor force throughout a colossal pistonic excursion range, guaranteeing extremely natural, low distortion sound at all levels.

The face of the driver has a smooth, uninterrupted profile to optimise its acoustic coupling to the air, while a second bonded layer at the rear makes the complete structure both extremely stiff and very well damped. This meticulously engineered design extends the working bandwidth of the driver by over two octaves beyond the crossover region which ensures much lower distortion than conventional woofer designs, and an exceptionally clean, neutral and accurate midrange with a stunning transient response.

Our Studio6 bass driver outperforms most 8-inch monitors, delivering an unparalleled bass extension to 33Hz in the compact PMC6-2 speaker. The larger 8-inch Studio8 unit employs the same technology but has an even larger excursion range, higher maximum SPL, and extension down to 25Hz in the PMC8-2 and subs.

0000008

PMC
www.pmc-speakers.com

Load Defaults
Press to begin

power
volume

digital out

analog signal in

DISCONNECT FROM LIVE SUPPLY BEFORE REMOVING CABLE

CAUTION - RISK OF ELECTRIC SHOCK - DO NOT OPEN
PRECAUTION - RISQUE DE CHOC ELECTRIQUE - NE PAS OUVRIRE
小心 勿开机壳 请勿打开
WARNING - DO NOT USE WITHOUT AN EARTHED MAINS CONNECTION DO NOT EXPOSE TO MOISTURE OR WATER
ATTENTION - NE PAS UTILISER SANS CONNEXION A LA TERRE NE PAS EXPOSER A L'UMIDITE OU A L'EAU

Model: PMC6 AMP
PMC Stock Code: S1160
Amp Serial No: 0000008
100-240V~
80-60Hz 400W
12 2021

DESIGNED, MADE & TESTED IN THE UK

network

100-240V~ 50-60Hz

ATL
Laminar
英国制造

CE

POWER, CONNECTIONS & CONTROL

Each driver in the PMC6, 6-2 and 8-2 monitors is independently powered by one of PMC's next generation of DSP-controlled Class-D amplifiers. Like the speaker drivers themselves, these have been designed from first principles for maximum transparency and resolution, with a high damping factor and ultra-low distortion, resulting in a flat frequency response at all levels.

With the PMC6, each drive unit is powered by a dedicated 200W amplifier; as well as offering maximum flexibility and control, the independent amplification keeps intermodulation to negligible levels. On the PMC6-2 and 8-2 this is doubled to 400W for each of the 4 drive units, resulting in a colossal 1600W per speaker, delivering jaw dropping dynamics without risk of clipping transient peaks.

Though immensely powerful, the cutting-edge 32-bit DSP controlling the amps and speaker crossovers merely finesses the performance of what are already state-of-the-art designs. The drivers are meticulously time-aligned and phase-corrected via 24dB-per-octave double-precision filters for the ultimate in non-fatiguing on- and off-axis response. As well as guaranteeing PMC's signature wide and sonically consistent dispersion, the DSP also provides non-invasive protection using excursion limiting, and allows users to create and store custom EQ balances to suit their own tastes and requirements via the class-leading, browser-based SoundAlign software.

The rear panel not only houses the control and amplifier electronics but also provides superb connectivity accepting analogue and digital inputs (16/24-bit AES3, 18 -192kHz sample rate), RJ45 for networking, digital output AES3 (fixed 24-bit @ 96kHz), plus a future-proofing expansion card slot for potential connectivity upgrades.

PMC6

| | |
|-----------------------------|--|
| Type | Active 2-way nearfield reference monitor with ATL™ bass loading |
| Drive unit complement | LF PMC 150mm (6") studio 6 driver HF PMC 27mm (1") soft dome tweeter |
| Effective ATL™ length | 1.8m (5.9ft) |
| Frequency response | 39Hz - 25kHz (- 3dB) (@1m full space, on-axis) |
| Sensitivity | +4dBu input signal = 98dB SPL @ 1m |
| Max continuous SPL | 106dB @1m (Half space value calculated as +3dB from full space measurement. Unweighted input, 20-20kHz Pink Noise (IEC) with 12dB CF for 2 hours AES2-1984 duration) |
| Max Peak SPL | 118dB @1m (Half space value calculated as +3dB from full space measurement. Unweighted input, 20-20kHz Pink Noise (IEC) with 12dB CF for 2 hours AES2-1984 duration) |
| Directivity | H +/-60 degrees V +50/-40 degrees (-6dB off axis @10kHz) |
| Input | XLR switchable between analogue & digital AES3 Analogue input - +20/+24dBu max. input level (selectable) - 22K ohm input impedance Digital input - 16/24-bit AES3 signal, left, right or left + right - 18 - 192kHz sample rate - 110 ohm input impedance Expansion card slot - For future connectivity upgrades |
| Output | XLR digital AES3 (fixed 24-bit @ 96kHz) |
| Network | RJ45 for use with PMC SoundAlign web interface |
| Features | Level Trim (+/-10dB) Orientation (portrait, landscape, auto) High-pass filter (20 - 200Hz, 12dB/Oct) Delay (0 - 30mS) Phase (normal or inverted) LF & HF shelving filters (20Hz - 20kHz, +/- 10dB, Q 0.707) Parametric EQ (5 bands, 20Hz - 20kHz, +/- 10dB) User presets (3 + factory defaults) |
| Latency | 2.4mS |
| Amplifier power per channel | LF 1 x 200Wrms HF 1 x 200Wrms |
| Mains | 100 - 240VAC auto-switching, 50-60Hz (IEC C14) |
| Power consumption (idle) | 35W |
| Power consumption (max) | 400W |
| Cabinet dimensions | H 400mm (15.7") W 215mm (8.5") D 372mm (14.6") (portrait) H 215mm (8.5") W 400mm (15.7") D 372mm (14.6") (landscape) |
| Weight | 11.1kg (24.4lbs) each |
| Available finishes | Black |



PMC6-2

| | | | |
|-----------------------------|--|-----------------------|-----------------------|
| Type | Active 3-way nearfield reference monitor with ATL™ bass loading | | |
| Drive unit complement | LF 2 x PMC 150mm (6") studio 6 drivers MF PMC55 55mm (2") soft dome mid-range HF PMC 27mm (1") soft dome tweeter | | |
| Effective ATL™ length | 2m (6.6ft) | | |
| Frequency response | 33Hz - 25kHz (- 3dB) (@1m full space, on-axis) | | |
| Sensitivity | +4dBu input signal = 98dB SPL @ 1m | | |
| Max continuous SPL | 109dB @1m (Half space value calculated as +3dB from full space measurement. Unweighted input, 20-20kHz Pink Noise (IEC) with 12dB CF for 2 hours AES2-1984 duration) | | |
| Max Peak SPL | 121dB @1m (Half space value calculated as +3dB from full space measurement. Unweighted input, 20-20kHz Pink Noise (IEC) with 12dB CF for 2 hours AES2-1984 duration) | | |
| Directivity | H +/-50 degrees V +60/-40 degrees (-6dB off axis @10kHz) | | |
| Input | XLR switchable between analogue & digital AES3 Analogue input - +20/+24dBu max. input level (selectable) - 22K ohm input impedance Digital input - 16/24-bit AES3 signal, left, right or left + right - 18 - 192kHz Sample Rate - 110 ohm input impedance Expansion card slot - For future connectivity upgrades | | |
| Output | XLR digital AES3 (fixed 24-bit @ 96kHz) | | |
| Network | RJ45 for use with PMC SoundAlign web interface | | |
| Features | Level Trim (+/-10dB) High-pass filter (20 - 200Hz, 12dB/Oct) Delay (0 - 30mS) Phase (normal or inverted) LF & HF shelving filters (20Hz - 20kHz, +/- 10dB, Q 0.707) Parametric EQ (5 bands, 20Hz - 20kHz, +/- 10dB) User presets (3 + factory defaults) | | |
| Latency | 2.4mS | | |
| Amplifier power per channel | LF 2 x 400Wrms | MF 1 x 400Wrms | HF 1 x 400Wrms |
| Mains | 100 - 240VAC auto-switching, 50-60Hz (IEC C14) | | |
| Power consumption (idle) | 50W | | |
| Power consumption (max) | 1500W | | |
| Cabinet dimensions | H 400mm (15.7") W 430mm (16.9") D 372mm (14.6") | | |
| Weight | 21.3kg (47lbs) each | | |
| Available finishes | Black | | |



PMC8-2

| | |
|-----------------------------|--|
| Type | Active 3-way nearfield reference monitor with ATL™ bass loading |
| Drive unit complement | LF 2 x PMC 200mm (8") studio 8 drivers MF PMC55 55mm (2") soft dome mid-range HF PMC 27mm (1") soft dome tweeter |
| Effective ATL™ length | 3m (9.8ft) |
| Frequency response | 25Hz - 25kHz (-3dB) (@1m full space, on-axis) |
| Sensitivity | +4dBu input signal = 98dB SPL @ 1m |
| Max continuous SPL | 113dB @1m (Half space value calculated as +3dB from full space measurement. Unweighted input, 20-20kHz Pink Noise (IEC) with 12dB CF for 2 hours AES2-1984 duration) |
| Max Peak SPL | 125dB @1m (Half space value calculated as +3dB from full space measurement. Unweighted input, 20-20kHz Pink Noise (IEC) with 12dB CF for 2 hours AES2-1984 duration) |
| Directivity | H +/-45 degrees V +/-50 degrees (-6dB off axis @10kHz) |
| Input | XLR switchable between analogue & digital AES3 Analogue input - +20/+24dBu max. input level (selectable) - 22K ohm input impedance Digital input - 16/24-bit AES3 signal, left, right or left + right - 18 - 192kHz Sample Rate - 110 ohm input impedance Expansion card slot - For future connectivity upgrades |
| Output | XLR digital AES3 (fixed 24-bit @ 96kHz) |
| Network | RJ45 for use with PMC SoundAlign web interface |
| Features | Level Trim (+/-10dB) High-pass filter (20 - 200Hz, 12dB/Oct) Delay (0 - 30mS) Phase (normal or inverted) LF & HF shelving filters (20Hz - 20kHz, +/- 10dB, Q 0.707) Parametric EQ (5 bands, 20Hz - 20kHz, +/- 10dB) User presets (3 + factory defaults) |
| Latency | 2.4mS |
| Amplifier power per channel | LF 2 x 400Wrms MF 1 x 400Wrms HF 1 x 400Wrms |
| Mains | 100 - 240VAC auto-switching, 50-60Hz (IEC C14) |
| Power consumption (idle) | 50W |
| Power consumption (max) | 1500W |
| Cabinet dimensions | H 534mm (21") W 551mm (21.7") D 440mm (17.3") |
| Weight | 39kg (86lbs) each |
| Available finishes | Black |



PMC8 SUB

| | |
|--------------------------|--|
| Type | Active subwoofer with an 8-inch bass driver and ATL™ bass loading |
| Drive unit complement | LF PMC 200mm (8") studio 8 driver |
| Effective ATL™ length | 3m (9.8ft) |
| Frequency response | 25Hz - 500Hz (-3dB) (@1m full space, on-axis) |
| Sensitivity | +4dBu input signal = 98dB SPL @ 1m |
| Max continuous SPL | 109dB @1m (Quarter space value calculated as +3dB from half space measurement. Unweighted input, 20-20kHz Pink Noise (IEC) with 12dB CF for 2 hours AES2-1984 duration) |
| Max Peak SPL | 121dB @1m (Quarter space value calculated as +3dB from half space measurement. Unweighted input, 20-20kHz Pink Noise (IEC) with 12dB CF for 2 hours AES2-1984 duration) |
| Input | XLR switchable between analogue & digital AES3 Analogue input - +20/+24dBu max. input level (selectable) - 22K ohm input impedance Digital input - 16/24-bit AES3 signal, left, right or left + right - 18 - 192kHz Sample Rate - 110 ohm input impedance Expansion card slot - For future connectivity upgrades |
| Output | XLR digital AES3 (fixed 24-bit @ 96kHz) |
| Network | RJ45 for use with PMC SoundAlign web interface |
| Features | Level Trim (+/-10dB) High-pass/Low-pass filter (20 - 200Hz, 12dB/Oct) Delay (0 - 30mS) Phase (normal or inverted) LF & HF shelving filters (20Hz - 20kHz, +/- 10dB, Q 0.707) Parametric EQ (5 bands, 20Hz - 20kHz, +/- 10dB) User presets (3 + factory defaults) |
| Latency | 2.4mS |
| Amplifier power | 300Wrms |
| Mains | 100 - 240VAC auto-switching, 50-60Hz (IEC C14) |
| Power consumption (idle) | 25W |
| Power consumption (max) | 300W |
| Cabinet dimensions | H 266mm (10.5") W 551mm (21.7") D 440mm (17.3") |
| Weight | 18.5kg (40.8lbs) each |
| Available finishes | Black |



PMC8-2 SUB

| | |
|--------------------------|--|
| Type | Active subwoofer with twin 8-inch bass drivers and ATL™ bass loading |
| Drive unit complement | LF 2 x PMC 200mm (8") studio 8 drivers |
| Effective ATL™ length | 3m (9.8ft) |
| Frequency response | 25Hz - 500Hz (-3dB) (@1m full space, on-axis) |
| Sensitivity | +4dBu input signal = 98dB SPL @ 1m |
| Max continuous SPL | 115dB @1m (Quarter space value calculated as +3dB from half space measurement. Unweighted input, 20-20kHz Pink Noise (IEC) with 12dB CF for 2 hours AES2-1984 duration) |
| Max Peak SPL | 127dB @1m (Quarter space value calculated as +3dB from half space measurement. Unweighted input, 20-20kHz Pink Noise (IEC) with 12dB CF for 2 hours AES2-1984 duration) |
| Input | XLR switchable between analogue & digital AES3 Analogue input - +20/+24dBu max. input level (selectable) - 22K ohm input impedance Digital input - 16/24-bit AES3 signal, left, right or left + right - 18 - 192kHz Sample Rate - 110 ohm input impedance Expansion card slot - For future connectivity upgrades |
| Output | XLR digital AES3 (fixed 24-bit @ 96kHz) |
| Network | RJ45 for use with PMC SoundAlign web interface |
| Features | Level Trim (+/-10dB) High-pass/Low-pass filter (20 - 200Hz, 12dB/Oct) Delay (0 - 30mS) Phase (normal or inverted) LF & HF shelving filters (20Hz - 20kHz, +/- 10dB, Q 0.707) Parametric EQ (5 bands, 20Hz - 20kHz, +/- 10dB) User presets (3 + factory defaults) |
| Latency | 2.4mS |
| Amplifier power | 2 x400Wrms |
| Mains | 100 - 240VAC auto-switching, 50-60Hz (IEC C14) |
| Power consumption (idle) | 50W |
| Power consumption (max) | 800W |
| Cabinet dimensions | H 534mm (21") W 551mm (21.7") D 440mm (17.3") |
| Weight | 37.5kg (82.7lbs) each |
| Available finishes | Black |



© 2021, The Professional Monitor Company Limited. All rights reserved.

SoundAlign and Laminair are trade marks of The Professional Monitor Company Limited

Dolby® and Dolby Atmos are registered trademarks of Dolby® Laboratories

This document should not be construed as a commitment on the part of The Professional Monitor Company Limited (PMC). The information it contains is subject to change without notice. PMC assumes no responsibility for errors that may appear within this document. Information subject to change.

This document should not be construed as a commitment on the part of The Professional Monitor Company Limited. The Professional Monitor Company Limited will not assume responsibility for errors that may appear in this document. Information may be subject to change.

Copyright © 2021. All rights reserved.

VIEW THE PRODUCTS ONLINE



THE PROFESSIONAL MONITOR COMPANY LIMITED
Holme Court Biggleswade SG18 9ST UK
T +44 (0)1767 686300

PMC USA LLC
Building 42 Suite H 17922 Sky Park Circle Irvine CA 92614 USA
T +1 949-861-3350

E sales@pmc-speakers.com W www.pmc-speakers.com

PMC[®]

Stock code no. 17387
Item no. 1250v2/Nov21