

PMC[®]

QUICK
SET-UP
GUIDE

PMC6

PMC6-2

PMC8-2

PMC8 SUB

PMC8-2 SUB

To access the full capabilities
of these loudspeakers please
download and read the

User Guide

pmc-speakers.com



SAFETY

- 1 Read and keep these instructions.
- 2 Heed all warnings and follow all instructions.
- 3 Water or liquids — Monitors should not be exposed to drips or splashes. Nor should objects filled with liquids, such as flower vases, be placed upon them.
- 4 Clean only with a dry non-abrasive cloth. Do not use solvents, abrasives, waxes or liquids as they may be detrimental to the cabinet finish.
- 5 Do not inhibit airflow around the unit. A free flow of air behind the loudspeaker is necessary to maintain sufficient cooling. A minimum of 80mm (3-inches) is required.
- 6 Installing these speakers into soffits may cause overheating and will invalidate the product warranty.
- 7 Do not install near heat sources eg: direct sunlight, radiators or other apparatus that produce heat.
- 8 This unit must be Earthed:
 - The unit is supplied with a suitable mains cable. If in doubt contact your PMC retailer/distributor.
 - Do not use the loudspeaker with an unearthed mains cable or an unearthed mains connection as this may compromise electrical safety.
 - *Apparatets stikprop skal tilsluttes en stikkontakt med jord, som giver forbindelse til stikproppens jord.*
 - *Laitte on liitettävä soujakoskettimilla varustettuun pistorasiaan*
 - *Apparatet må tilkoples jordet stikkontakt*
 - *Apparaten skall anslutas till jordat uttag*
- 9 Protect the power cord from being walked on or pinched, particularly at inlets and outlets.
- 10 The amplifier is not disconnected from the mains supply unless the power cord is removed from the unit or the mains outlet.
- 11 Unplug this unit during lightning storms or when unused for long periods.
- 12 There are no user-serviceable parts inside. Refer all servicing to qualified personnel. Servicing is required when the unit has been damaged in any way, produces abnormal odours, has been exposed to liquids, rain or moisture, does not operate normally, or has been dropped.
- 13 Ensure the loudspeakers do not tip/fall and cause injury or damage. Only use with accessories and brackets specified by PMC, and ensure all stands and fittings are safe and secure.
- 14 These monitors can produce high sound pressure levels (SPLs). Exposure to high SPLs has the potential to cause hearing damage. Adjust the system's sound pressure level to remain within safe limits.
- 15 Powerful magnets employed in these loudspeakers may have a detrimental effect on magnetically sensitive items if placed too close, such as CRT televisions, audio/video tape and cassettes.
- 16 Disconnect the speaker from the mains supply before removing an expansion card or the expansion card blanking cover. Ensure that an expansion card or the expansion card blanking cover is fitted and secured in place before reconnecting the speaker to the mains supply.
- 17 Only use in non-tropical climate areas and below an altitude of 2000m.  
- 18 Warning! This is a Class-A device. This device may cause interference in residential areas; in this case, the operator may be required to take appropriate measures.
- 19 Packaging can pose a danger to the young and vulnerable. Ensure these items are stored or disposed of safely, and in accordance with your local legislation.
- 20 PMC has made every effort to provide accurate installation information and good quality fixings. However, PMC will not be held responsible or liable for injuries or property damage (direct, indirect or consequential) arising out of use or inability to use this product safely and properly.
- 21 The manufacturing date code of this product is marked on the rear of the product in the format WW/YYYY.

To access the full capabilities of these loudspeakers please download and read the

User Guide

pmc-speakers.com



CONTROLS & CONNECTIONS

6-2
8-2
8 SUB
8-2 SUB

6

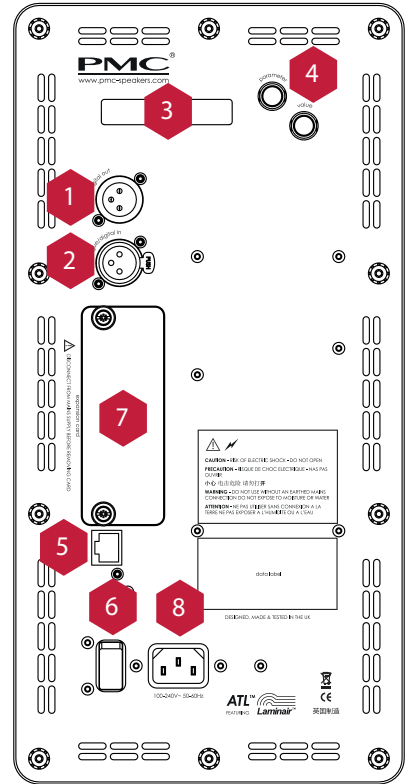
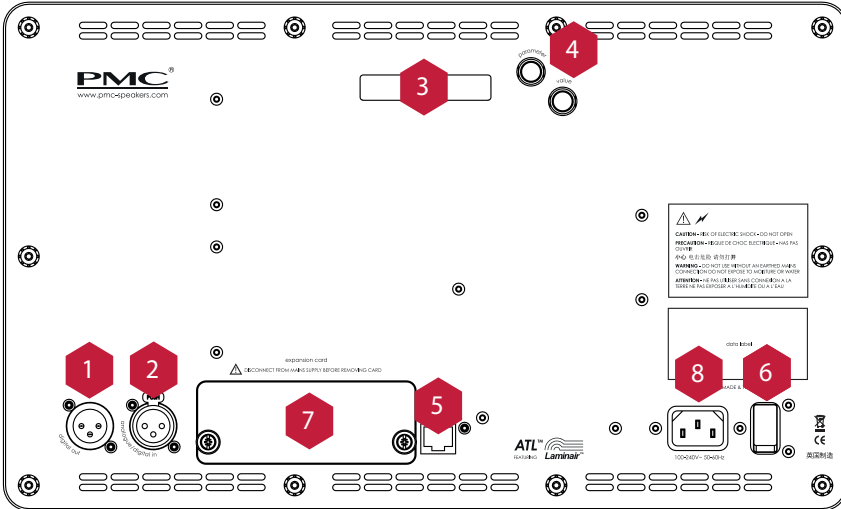

- 1 Analogue & Digital Input XLR** Accepts either analogue or AES3 digital input signals. The input source is set through the rotary encoders **4** or the SoundAlign interface. If set to analogue but fed with an AES3 input signal a low-level pink-noise will be heard. This will not cause harm.
- 2 Digital Output XLR** AES3 digital output for daisy-chaining this speakers' audio input to another speaker.
- 3 LCD Screen** The top row indicates the PARAMETER and the bottom row displays the VALUE of that parameter.
- 4 Rotary Encoders** Used to modify the speaker's settings. Rotate the top encoder to change to a different PARAMETER. Rotate the bottom encoder to modify the parameter VALUE.
- 5 Network Connector** RJ-45 Ethernet connector for network control of the speaker's settings using the SoundAlign interface. SoundAlign can be accessed by navigating to <http://soundalign.local/> or the speaker's IP address (shown on the LCD screen) in a browser. See full manual for more details.
- 6 Power Switch** This switches the speaker on or off, but doesn't isolate it from the mains supply. I = ON, O = OFF
- 7 Expansion Card Slot** Expansion card slot for future connection options. Disconnect the speaker from the mains supply before installing or removing an expansion card. Ensure the expansion card or blanking plate is securely fitted before connecting the speaker to the mains supply.
- 8 Power Inlet** Universal mains input 100 to 240VAC. An Earthed (three-wire) mains cable must be used.

POSITIONING

Acoustic Centres

The acoustic centre is the reference point for aligning these loudspeakers, as shown by the + symbol.

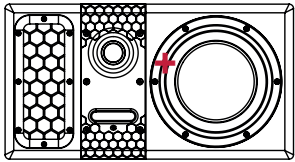

PMC6 (landscape)

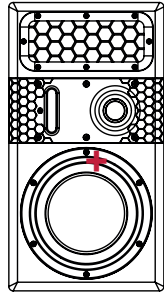

PMC6 (portrait)

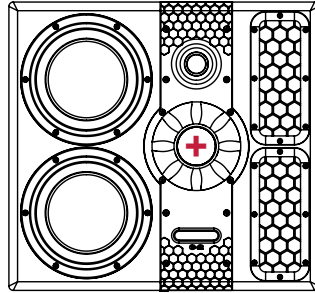

PMC6-2

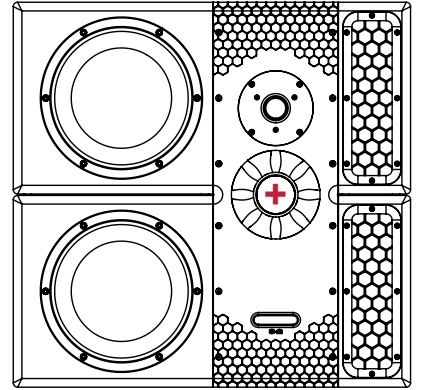

PMC8-2

NB: The PMC6 model features an entirely unique 'adaptive crossover'. The speaker can detect whether it has been placed in a portrait or landscape configuration and automatically adapts its crossover accordingly.

Speaker Placement

Avoid placing objects in front of the loudspeakers as this will degrade the stereo imaging and tonal balance.

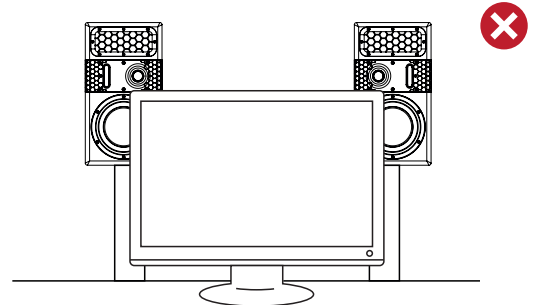
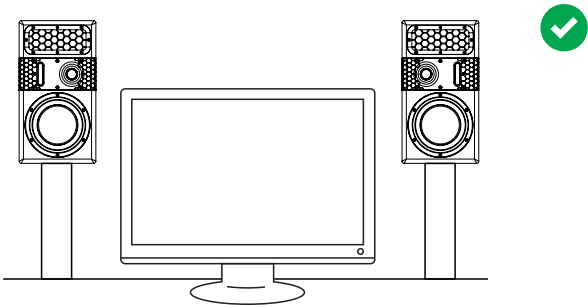

Vertical Angle

Position or angle the loudspeakers to align the acoustic centre with the listener's ears.

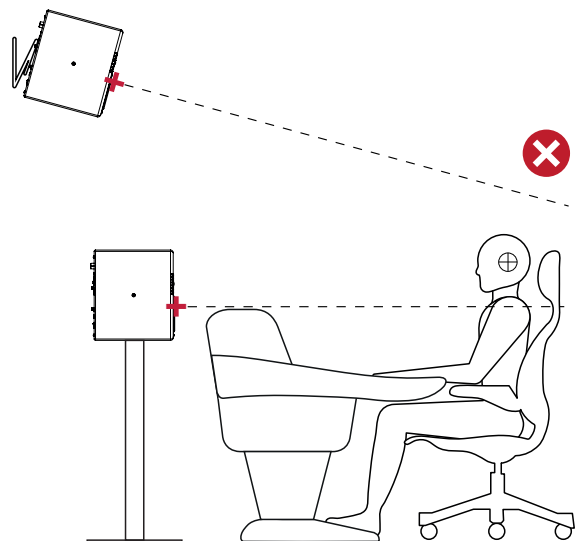
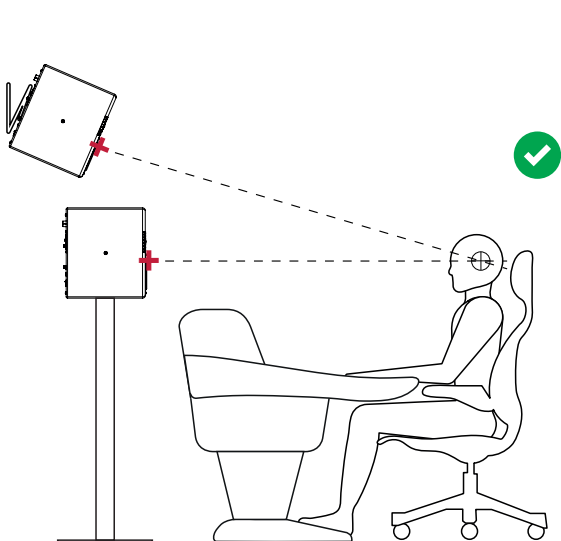

STEREO & SURROUND POSITIONING

For a stereo array, place the loudspeakers at two corners of an equilateral triangle. The toe-in angle of the speakers can be adjusted to optimise the stereo image as illustrated.

NB: Place the speakers as symmetrically as possible within the room to maximise the stereo imaging and provide the most even tonal balance.

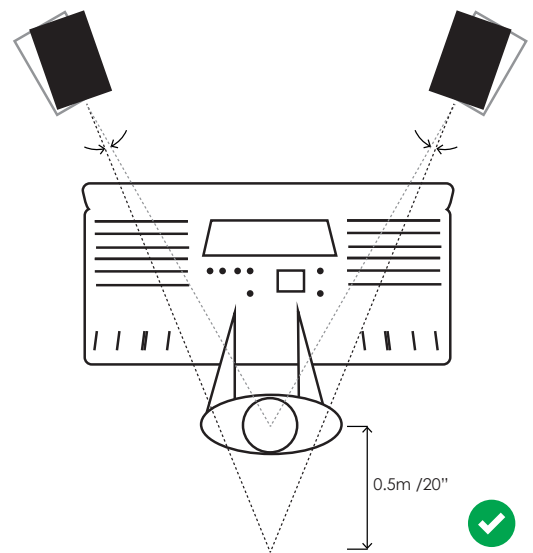

There are a variety of recommended speaker position and angle specifications for different surround sound and immersive arrays. In general, though, all of the loudspeakers should be aimed directly at the listening position. It is also vital to maintain a symmetrical arrangement, as shown below.

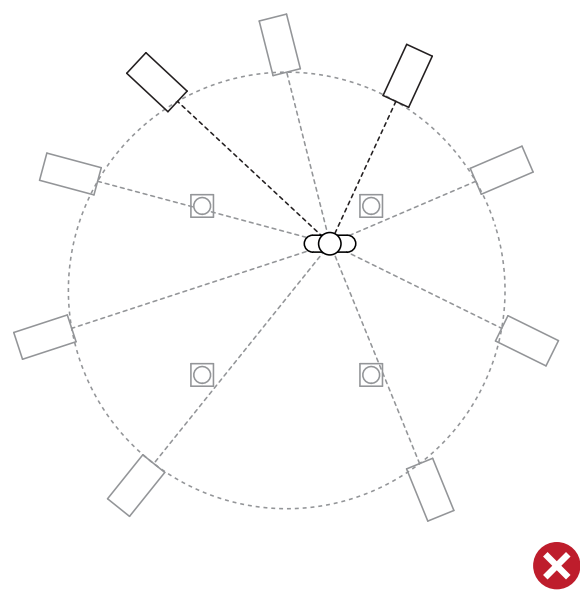
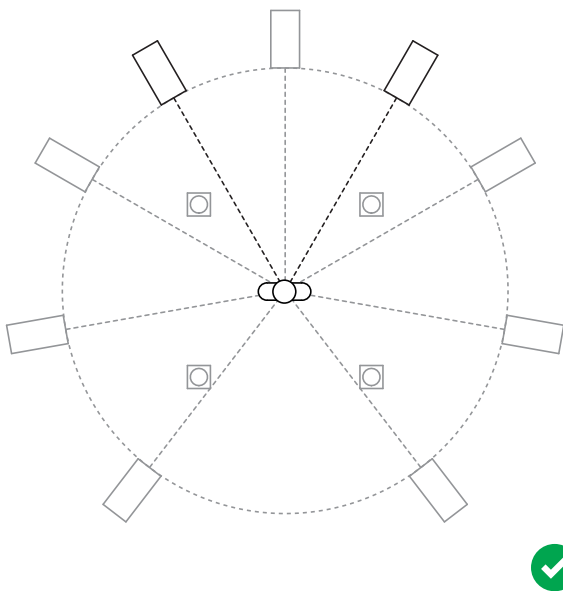

BOUNDARY EQUALISATION

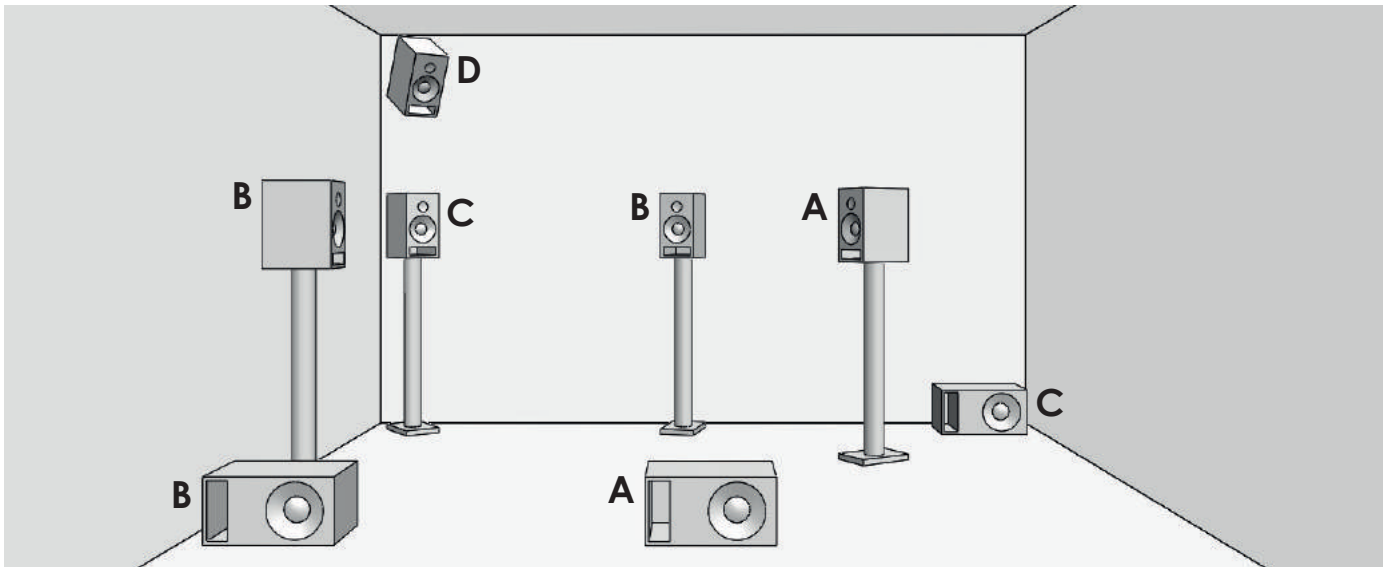

Placing a speaker near to a room boundary will increase its bass response. Four preset EQ curves are provided to compensate for this effect and maintain a flat, neutral response. The preset EQs are selectable via the encoders or SoundAlign network interface. The typical bass response for each speaker position before and after compensation is shown below (red = no compensation, green = correct response).

A. Free Space

More than 0.5m (20") away from all walls / ceiling / floor
(flat response – no compensation necessary)

B. Wall

Within 0.5m (20") of one wall, but away from corners

C. Corner

Within 0.5m (20") of two walls, or wall-ceiling / wall-floor

D. Tri-Corner

Within 0.5m (20") of two walls and the ceiling or floor
(Select Corner mode and add parametric EQ of -4dB LF Shelf @ 45Hz)

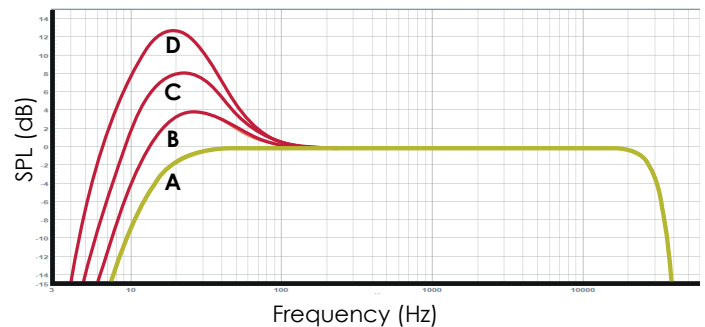

NB: All subs are already equalised for being placed on the floor. If a sub is positioned on the floor near one wall select 'Wall', if positioned on the floor near two walls select 'Corner'.

Desk Filter

Console or desktop reflections can cause a narrow-band peak in the lower-mid frequency. This can be corrected with a Desk Filter EQ option which is accessed via the encoders or the SoundAlign network interface.

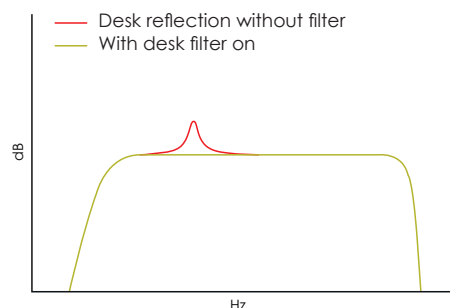
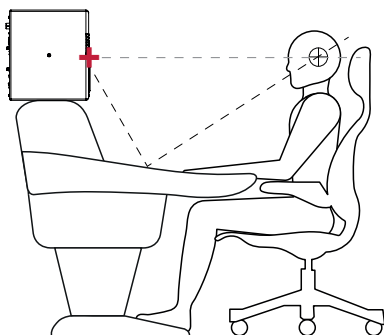

CREATING AN XBD SYSTEM

Each of the full range monitors can be combined with a sub to form an XBD system to increase bass extension and/or bass headroom. An XBD system provides better sonic integration than can be achieved with a conventional subwoofer. The XBD configurations and settings are shown below:

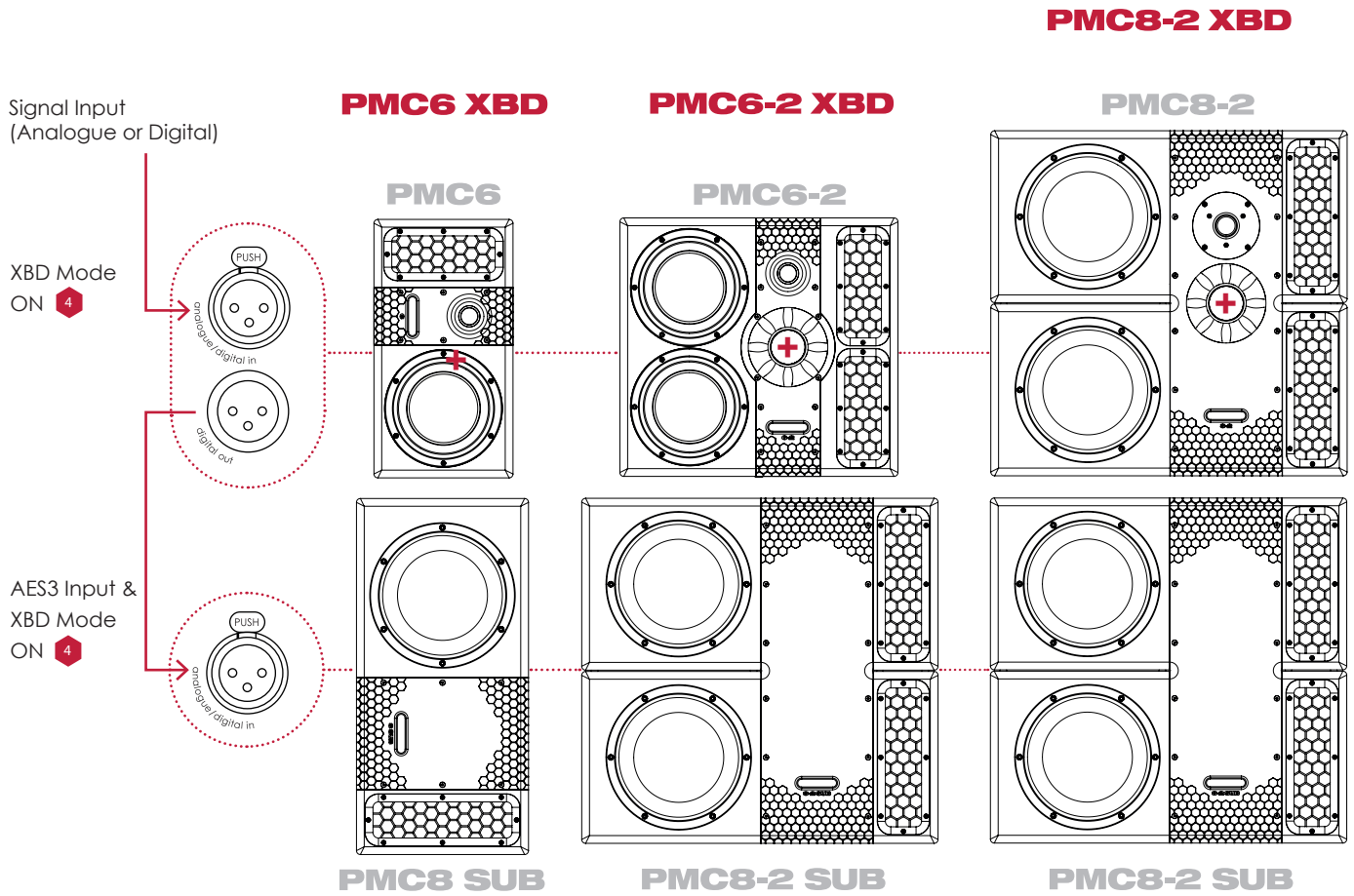

NB: The acoustic centre (+) of the complete XBD system is defined by the master speaker as shown above.

Please download the full user guide from the PMC website for further information on other control configurations.

SPECIFICATIONS

	PMC6	PMC6-2	PMC8-2
Type	Active 2-way reference monitor	Active 3-way reference monitor	Active 3-way reference monitor
Usable frequency response	39Hz - 25kHz (- 3dB) (@1m full space, on-axis)	33Hz - 25kHz (- 3dB) (@1m full space, on-axis)	25Hz - 25kHz (- 3dB) (@1m full space, on-axis)
Effective ATL™ length	1.8m (5.9ft)	2m (6.6ft)	3m (9.8ft)
Drive unit complement	LF PMC 150mm (6") new studio 6 driver HF PMC 27mm (1") soft-dome tweeter	LF 2 x PMC 150mm (6") new studio 6 driver MF PMC55 55mm (2") soft dome mid-range HF PMC 27mm (1") soft-dome tweeter	LF 2 x PMC 200mm (8") new studio 8 driver MF PMC55 55mm (2") soft dome mid-range HF PMC 27mm (1") soft-dome tweeter
Max continuous SPL	106dB @1m	109dB @1m	113dB @1m
Max Peak SPL	118dB @1m	121dB @1m	125dB @1m
Amplifier Power per Channel	LF 1 x 200Wrms HF 1 x 200Wrms	LF 2 x 400Wrms MF 1 x 400Wrms HF 1 x 400Wrms	LF 2 x 400Wrms MF 1 x 400Wrms HF 1 x 400Wrms
Cabinet dimensions	H 400mm W 215mm D 372mm (portrait) H 215mm W 400mm D 372mm (landscape)	H 400mm W 430mm D 372mm	H 534mm (21") W 551mm (21.7") D 440mm
Weight	11.1kg (24.4lbs) each	21.3kg (47lbs) each	39kg (86lbs) each

	PMC8 SUB	PMC8-2 SUB
Type	Active subwoofer	Active subwoofer
Usable frequency response	25Hz - 500Hz (- 3dB) (@1m full space, on-axis)	25Hz - 500Hz (- 3dB) (@1m full space, on-axis)
Effective ATL™ length	3m (9.8ft)	3m (9.8ft)
Drive unit	PMC 200mm (8") new studio 8 driver	PMC 2 x 200mm (8") new studio 8 drivers
Max continuous SPL	109dB @1m	115dB @1m
Max Peak SPL	121dB @1m	127dB @1m
Amplifier Power per Channel	LF 300Wrms	LF 2 x 400Wrms
Cabinet dimensions	H 266mm W 551mm D 440mm	H 534mm W 551mm D 440mm
Weight	18.5kg (40.8lbs) each	37.5kg (82.7lbs) each

SHARED SPECIFICATIONS

Input connectors	XLR switchable between analogue & digital AES3
Output connectors	XLR digital AES3 (96kHz)
Input sensitivity	+20 or +24dBu with +/-10dB trim
Digital sample rate	18-192kHz, 24-bit via internal sample rate converter
Mains power	100 - 240VAC auto-switching, 50-60Hz
Available finishes	Studio black

